

# General Science

CLASS IX-X



**PUNJAB CURRICULUM AND  
TEXTBOOK BOARD, LAHORE**

All rights reserved with **Punjab Curriculum and Textbook Board**, Lahore.  
Approved by the Federal Ministry of Education, (Curriculum Wing) Islamabad  
vide letter No. F.6-5/2003 dated 22 Dec, 2003.

Government of Pakistan, Islamabad.

## CONTENTS

No.	Chapter	Page No	No.	Chapter	Page No
1	Introduction and Role of Science	1	7	Energy	91
2	Our Life and Chemistry	14	8	Current Electricity	110
3	Biochemistry and Biotechnology	29	9	Basic Electronics	128
4	Human Health	40	10	Science and Technology	150
5	Diseases, Cause and Prevention	52	11	Space and Nuclear Programme of Pakistan	168
6	Environment and Natural Resources	71	(i)	Index	176

## Authors

- \* Prof. Nazir Ahmad Chughtai
- \* Prof. Dr. Ejaz Rasool
- \* Dr. Capt. Muhammad Akhtar (R)
- \* Prof. Mrs. Rizwana Cheema
- \* Mr. Aamir Riaz
- \* Prof. Dr. Javed Iqbal
- \* Dr. Mahmood -ul-Hasan
- \* Prof. Muhammad Nisar
- \* Prof. Surriya Usmani (R)

## Editors

- \* Prof. M. A. Shahid
- \* Prof. Shahnawaz Cheema
- \* Dr. Abid Zia
- \* Prof. Muhammad Nisar

**Supervision:** Syed Saghir-ul-Hassnain Tirmizi,  
Subject Specialist, PCTB, Lahore

**Director (Manuscripts):** Dr. Mobeen Akhtar

**Artist/Deputy Director (Graphics):** Aisha Waheed

**Published by:** Punjab Curriculum and Textbook Board, Lahore

**Printed by:** Ali Imran Rajput Printers, Lahore

Date of Printing	PMIU	PEF	Total opies
January 2018	215843	386	216229



# 1 INTRODUCTION AND ROLE OF SCIENCE

In this chapter you will learn:

- Introduction of Science
- History of Science
- Concept of Science in Islam
- Contribution of Muslim and Pakistani Scientists
- Branches of Science
- Role of Science and Technology
- Limitations of Current Science

The word “Science” is derived from the latin word “Scientia”, which means to study and analyse facts in original form. The basic principle of science is observation and hypothesis. To establish scientific law in the light of experiments is called scientific method.

## 1.1 History of Science

The history of science is as old as the man himself. With the passage of time man learnt from his interaction with the surroundings which later added to his knowledge of science e.g., when he burnt first time the wood for fire, he basically discovered the process of combustion and he also came to know that wood burns but a stone does not.

Greek philosophers took special interest in science as they did in other subjects. They took interest in science even before 500 B.C. Greeks were not interested in proving their ideas through experiments. They had a firm belief that life is based on air, water, earth and fire and these four elements make different things when combined in different proportions.

600 A.D. to 1400 A.D. is the era of Islamic chemistry. In this period many intelligent and research minded scholars observed the properties of matter. They carried on new experiments and discovered elements like “Arsenic”. Besides this, a number of compounds were made. Experimental tools like retort were made for distillation. The period of Alchemy was no doubt the period of muslim scientists. They presented chemistry as experimental science for the first time. Many experiments were performed in this period and many new chemical reactions were discovered.

In 13<sup>th</sup> century muslims brought a complete change in the field of chemistry and they dominated for about seven centuries until Chingiz Khan and Halaku Khan destroyed the Islamic world. Gradually the western scientists who got knowledge from muslim universities took over the task of developing science from the muslims. They introduced these scientific approaches in Europe, which are still practised. Modern age scientists are Galileo, Isaac Newton, Gregor Mendel, Edison, Marconi, Einstein and many others.

## 1.2 Concept of Science in Islam

Islam is a complete code of life. It gives us a clear and real picture of the facts and invites us to utilize natural resources for the benefit of mankind.

Islam is a practical religion and it is based on logic, observations, experiments and results. Many verses of the Holy Quran point out these factors clearly. The Holy Quran says:

- Don't they see?
- Don't they think over it?
- Don't they ponder upon it?

Teachings of the Holy Quran make us more inquisitive about our surroundings even the first ever words of the Holy Quran are very clear about this:

- Read! In the name of thy Lord and Cherisher, Who created. Created man, out of a clot of congealed blood. Read! And thy Lord is most Bountiful. He Who taught (the use of) the Pen. Taught man that which he knew not (Surah: 96 verse 1-5).

Like Quranic verses there are many hadiths in which emphasis is given on the knowledge, its importance and obligation on muslims. For examples Muhammad (peace be upon him) said:

- “To seek knowledge is the obligation of every man and woman.”

Like this, another hadiths is

- “Seek knowledge from lap (cradle) to grave.”

Allah says:

- “And of every thing We have created pairs: that ye may receive instruction. (Surah:51,verse: 49)”

We are observing pairs in human beings and other living creatures, however, scientists tell that Allah has made everything in pairs including smallest insects to the biggest creature of the sea. Only males and females reproduce offsprings of animals and plants.

If the human being ponder on these things, they can understand God's power & oneness for further guidance.

Allah Says:

- If the ocean were ink ( where with to write out) the words of my Lord, sooner would the ocean be exhausted than would the words of my Lord, even if we added another ocean like it, for its aid. (Surah: 18, Verse: 109)

This tells us that human knowledge & wisdom is unable to the known facts of nature.

Allah Says:

- It is only a little knowledge that is communicated to you. (Surah: 17, Verse: 85)

Great scientists cannot claim to understand reality and their views keep on changing day by day. Quran invites us to think, which is the basis of science.

#### Activity

Read carefully the verse-164 of Surah Al-Baqarah alongwith its translation and make a list of natural phenomena. Do these phenomena introduce us the laws of nature?

## 1.3 Contribution of Muslim and Pakistani Scientists.

### (a) Jabir Bin Hayyan (722-817 A.D.)

Jabir Bin Hayyan is said to be the founder of chemistry. He discovered methods to extract metals from ores, making steel, leather, dyeing cloths and protecting iron from rust. He prepared chemicals like nitric acid, sulphuric acid and hydrochloric acid. Jabir Bin Hayyan was the discoverer of many other chemical compounds. He also knew the methods for the preparation of varnish. Jabir Bin Hayyan was the first chemist who had his own laboratory.

He knew about the process of fractional distillation. Jabir Bin Hayyan wrote books about chemistry and related topics in arabic. Among these books Al-Kitab and Al-Khalis are very famous books. The translation of his book Al-Chemia in Latin was done by an English man Robert of Chester in 1144. In 1892 Mu Aw Homus translated nine books of Jabir Bin Hayyan in French.

### (b) Muhammad Bin Zikrya Al-Razi (865-925 A.D.)

His full name was Abu Bakar Muhammad Bin Zikrya Al-Razi. He was born in “Ray” now Tehran in 865 A.D. He was not only a chemist but a great physician as well. He was an experienced surgeon and administrator of a hospital in Baghdad. He was the first person to use opium to make his patients unconscious. He was the first person to explain in detail the causes, symptoms and treatment of chicken pox and small pox. His theories and ideas about these diseases are still practised. He was the first person to prepare alcohol from fermentation.

He classified chemicals substances into four groups.

1. Minerals
2. Botanicals
3. Animals
4. Derived

This classification of chemical compounds done by Al-Razi is still accepted.

**(c) Ibn-ul-Haitham (965-1039 A.D.)**

His full name was Abu Ali Al-Hasan Ibn-ul-Hassan Al-Basri. He is known as Al- Hazen in the west. He identified inertia of matter, a theory which was later developed by Newton and called laws of motion. He discovered the pinhole camera.

The name of his book, which is reputed all over the world, is “Kitab-ul-Manazir.” It is a complete mathematical and practical book about the specialties of light. Ibn-ul-Haitham is considered to be the first expert on the laws of refraction, reflection besides lens and mirrors. The detail that Ibn-ul-Haitham had presented about eye is considered to be the right even now after going through many experiments. Roger Bacon has mentioned the name of Ibn-ul-Haitham in his literary work again and again.

**(d) Al-Bairuni (973-1048 A.D.)**

Al-Bairuni’s full name was Burhan-ul-Haq Abu Rehan Muhammad Bin Ahmad. He was called as Al-Bairuni from the very beginning. He was born in Khawarizam on September 4, 973. He got his early education from Abu-Naser Mansoor, a great philosopher and mathematician of his time.

Al-Bairuni was a physician, astronomer, mathematician, physicist, geographer and a historian all at the same time. He was appointed as historian and scholar in the court of Sultan Mahmood Ghaznavi. He discovered that light travels faster than sound.

He discovered that radius of the earth was 6338 km. He discovered it near Pind Dadan Khan, District Jehlum about 100 km south east of Islamabad, the capital of Pakistan. The latest measure of the earth’s radius is 6353 km with a difference of only 15 km. He made great contribution in the fields of astronomy, astrology, mathematics and geography.

During his visit to the sub-continent he discovered that the Sindh-valley was under the sea, with the passage of time the seawater receded and the valley came into being. Modern geologists agree with his idea. He wrote about 150 books on Mathematics. The name of famous book of Al-Bairuni is “Tahreer-ul-Amakin”.

**(e) Bu Ali Sina (980-1037 A.D.)**

His full name was Abu Ali Al-Hussain Ibn-Abdullah. He is very well known as Avenca in Europe. He is considered Aristotle of the muslim world. He wrote a research article on 760 herbs. It shows that he was not only a chemist but also an expert in medicine. He was the first person to reject the idea of converting common metal into gold. He wrote about 100 books on philosophy, science, fiqah, literature and biology. His famous book on philosophy is Kitab-al-Shifa. In this famous book along with the subjects of physics, chemistry, mathematics too much

has been discussed about subjects like music and biology. His great work on medicine is his famous book Al-Qanoon-fil-Tib. It consists of 14 volumes. It explains the making and working of different parts of human body. This book was taught as a textbook in western universities until the late 17<sup>th</sup> century.

## Pakistani Scientists

### (a) Dr. Abdus Salam

The only nobel prize winner scientist of Pakistan Dr. Abdus Salam was born at Santok Das District Sahiwal on January 29, 1926. After studying in Govt. College Jhang and Lahore he proceeded to England where he did his M.Sc. in mathematics and physics from Cambridge university in 1948-49 and won the Smith prize. He joined Government College Lahore in 1951 and became head of the mathematics department.

He went back to England in 1954 and started teaching mathematics at Imperial College, and stayed there until 1956. He served as member of Pakistan Atomic Energy Commission from 1958 to 1974. He worked as scientific advisor to the president of Pakistan from 1961 to 1974. SPARCO was established in 1961 and he was appointed as its chairman. He proposed the establishment of Islamic Science Foundation during the OIC meeting in Lahore in 1974. He founded Academy of Third World of Science in 1983 and became its president. He also founded an International Institute for theoretical physics in Italy and remained its head for the rest of his life. Dr. Abdus Salam put forward theory of the unification of two natural forces i.e., the weak nuclear force and electromagnetic force. In 1979 along with Weinberg and Gloschow won the nobel prize for his work in theoretical physics Dr. Abdus Salam is the only Pakistani scientist who got nobel prize.

### (b) Dr. Abdul Qadeer Khan

The world known scientist of Pakistan, Dr. Abdul Qadeer Khan was born on April 1st 1936 in Bhopal (India). He received his early education in Bhopal and in 1952 his family migrated to Karachi, where he did his B.Sc. from D.G. Science college. He joined government service but very soon left it and went to Europe in 1961, where he studied at Shorlton Berg University in Germany for two years. Then he did his M.Sc from Technology University Hague (Holland). Later he did his Ph.D. from Leaven university, Belgium. He was appointed as research assistant in the same university. He came back to Pakistan in 1975 permanently due to his patriotic spirit, and was appointed as director of Kahuta Research Laboratories, which was later re-named as Dr. A.Q. Khan Research laboratory as a tribute to the great scientist. Along with other Pakistani scientists he successfully tested the nuclear devices at Chaghi in Balochistan on May 28, 1998. As a result of that Pakistan became Atomic Power. Pakistani nation cannot forget the services rendered by Dr. Abdul Qadeer Khan and will salute Dr. Abdul Qadeer Khan with the core of its heart.

**(c) Dr. Munir Ahmad Khan**

Dr. Munir Ahmad Khan was born in Kasur in 1926. He shifted in 1937 from Qasur to Lahore. He got his early education in Central Model school Lahore and then graduated from Govt. college Lahore. He did his B.Sc. in Electric Power from University of Engineering and Technology Lahore in 1949. He also got M.Sc. degree from an American college in 1951. Dr. Munir Ahmad Khan joined service in International Atomic Agency in Vienna in 1957 and stayed there till 1971. He was appointed as chairman of Pakistan Atomic Energy Commission in 1972 and retired from the services of commission in 1990. Under his guidance, lot of progress was made in the fields of agriculture research, atomic energy and medicine.

**(d) Dr. Atta-ur-Rehman**

Dr. Atta-ur-Rehman was born in Dehli in 1942, migrated to Lahore in 1947. He got his early education from Karachi Grammar School. He did his B.Sc. (honours) from Karachi University in 1963. He got Ph.D. degree from Cambridge University in 1968. In 1977 he was appointed as co-director in Hussain Jamal institute of chemistry and then promoted as director in 1990. His services are highly appreciated in the field of medicine. He has published more than 200 research papers and lot of people have benefitted from him. He has received lot of national and international awards.

**(e) Dr. Samar Mubarak Mand**

Dr. Samar was born in Rawalpindi on september 17, 1941. He passed his matriculation from Saint Anthony High School Lahore in 1956. He did his M.Sc. in Physics from government college Lahore in 1962. He did his M. Phil in Nuclear Physics from Oxford University England in 1966.

Dr. Samar Mubarak Mand started his career as a scientific officer in Pakistan Atomic Energy in 1962. He was ranked as a director general in 1994, and in 1996 he was made technical member.

His special achievement was the responsibilities given by the Prime Minister of Pakistan to lead the team of Nuclear Scientist at Chaghi to conduct six nuclear tests for Pakistan. These nuclear tests were successfully conducted on 28th and 30th May 1998. As Director General of National Development Complex, he designed and developed “Shaheen” medium range missiles, which were successfully tested on April 15, 1999.

**(f) Dr. Ashfaq Ahmad**

Dr. Ashfaq Ahmad passed his M.Sc. in physics from government college Lahore in 1951. He taught in government college Lahore from 1952 to 1960. He went to Canada where he did his Ph.D. from Montreal university. He went to Neils Bohr Institute, Coupan Hagen and Sorborn for higher studies. He joined Pakistan Atomic Energy Commission in 1960. He was made Chairman

of Pakistan Atomic Energy Commission in 1991, where he did his best to improve the working of the commission. He is attached with our National Nuclear Programme from the last 25 years. He is one of the pioneers of our nuclear compatibility.

## 1.4 Branches of Science

Science is a vast subject. For our own convenience we divide it into various branches like other subjects.

### (a) Physics

Physics is that branch of science, which deals specially with matter and energy. It is also called the science of measurement because it deals mostly with measurement. Mechanics, heat, light, sound, electricity etc. are its main branches.

### (b) Chemistry

Chemistry is that branch of science, which deals with nature, composition, and chemical properties of various things.

A number of chemical reactions are being produced at any time in the world. In our body a large number of chemical reactions are occurring e.g., digestion of food, formation of blood, purification of blood etc. Physical, inorganic and organic chemistry are its main branches.

### (c) Biology

It is a study of living things. The word biology is derived from two Greek words i.e., “bios and logos”. Bios means life and logos means arguments. Living things include man, animals and plants. In this we study the growth, working and re-production of living things. It has two main branches:

1. **Botany:** It deals with the study of plants. It includes their structure and growth, and interaction with their environment.
2. **Zoology:** It deals with the study of animals. It includes their structure, growth and interaction with their environment. Most of the characteristics in plants and animals are common.

When plants and animals are studied together, the branch is called biology.

### (d) Astronomy

It is the study of the universe e.g., Sun, Earth, stars etc. Mathematics and physics play an important role in astronomy.



### (e) **Mathematics**

Mathematics is the knowledge about numbers and measurements, which includes calculations, algebra and geometry, etc. Mathematics is helpful in many other sciences. It helps us to explain long theories and ideas briefly, and results can be deduced easily. Newton and Einstein were great mathematicians.

### (f) **Agriculture**

It deals with land cultivation and livestock. It tells us how to grow crops and how to control their losses. Cultivation devices, machinery, fertilizers and pesticides are also included in this science.

### (g) **Medicine**

It is that branch of science, which deals with knowledge of human anatomy, diagnosis of diseases and their cure. It also includes pharmacy, instruments and machines used in diagnosis and treatment.

### (h) **Geography**

Geo means earth and graphy means graph marking. In geography, the different parts of the earth are marked graphically like the dry regions and wet regions. There is a discussion about human relationship, vegetation, air, water, soil and the structure of the terrestrial globe in the subject of geography.

## **Relationship of Different Branches of Science**

Different branches of science have a deep relationship with one another. For instance physics and chemistry are connected with each other. The concept that matter is made up with the mingling of different atoms has always been a subject of physics. Also the structure of atom is included in physics. But the formation of molecules by atoms and its causes have been a subject of chemistry. Physics describes the physical properties of matter and explain the laws according to which atoms combine to make molecules. But the formation of molecules shows the chemical characteristic. There is a great relationship between chemistry and biology. In biology the functioning of different organs and their structures are described. But different living bodies and the chemical reactions taking place in them are related to chemistry, which is called biochemistry.

Mathematical assistance is applied for the mathematical solution of different quantities of physics and chemistry. Many laws of physics and chemistry are derived by mathematics. Some of the branches of science studied collectively are mentioned below:

### **1. Biophysics:**

Biology is studied with the help of the principles of physics.



## 2. **Biochemistry:**

Biology is studied with the help of chemistry.

## 3. **Geophysics:**

Different aspects and characteristics of land are analysed with the help of physics.

## 4. **Astrophysics:**

When the whole universe (astronomical phenomena) is studied in context with the laws of the physics it is called Astrophysics.

## 1.5 Role of Science and Technology in our Life

Various articles of daily use e.g., the wheel of clay-man, the forge of blacksmith, the spindle of weaver, the rahat and plough of farmer and the oarage boats etc. are the result of ancient knowledge and technology.

Generation and supply of electricity, in mid 19<sup>th</sup> century resulted in various domestic and industrial inventions. Electricity not only provides light but also runs various industrial and home appliances. As a result, increase in industrial production occurred.

Various discoveries and inventions in the present century have brought a revolution in communication sector. Wireless, telephone, radio, television, computer and satellites have interlinked the whole world. The man has made the travel in space possible.

Today computer rule the world. This invention of modern world, have brought a revolution in every field of life. E-mail has become quick means of communication. Computers have also provided a convenient means of photography. Through internet, one can easily get information from all around the globe. The data can easily be saved and retrieved.

We use science and technology to live a comfortable life. Today, there is hardly any field not affected by science and technology. In agriculture sector, it is the production of high yielding varieties, pesticides, fertilizers and farm machinery. In industrial sector, the use of automatic electrical and mechanical machines, in communication introduction of supersonic planes, electrical trains and in medical, use of life saving drugs and diagnostic instruments are the result of advancement in the field of science and technology.

## 1.6 Limitations of Current Science

In last half a century, there has been a rapid expansion and advancement in the field of science and technology. New inventions are added everyday. Things which were considered impossible, now have become very common.

But despite of all these achievements, there are several matters where science is still helpless. Human knowledge cannot be perfect. Science also has some of its own limitations beyond which it has not yet been successful.

In the medical section hormones and vaccines against various non-curable diseases have been produced through genetic engineering, but genetic diseases are still incurable. The study of genome is not complete yet. Diseases like aids and hepatitis could not be controlled. Cancer is still incurable disease.

Despite of producing better varieties of crops through nuclear rays and genetic engineering, the food problem for the mankind could not be solved completely. It needs such plant variety which can fulfill the needs of ever growing population.

Space research has no limits. Landing on moon is only the first step. The conquest of Mars and other planets thereafter are challenging.

Ever growing population has increased the demand of energy. The natural resources hidden under the earth for centuries are exhausting. The substitute resource have not been developed with the same pace. No doubt, the use of nuclear energy for peaceful purposes is increasing, but it has also its own problems. A main problem of this is the disposal of nuclear waste.

Despite of all the research and development, natural disasters could not be controlled. For examples destructions by earthquakes are still the same. Scientists could not succeed to be aware of them before time, nor they have succeeded to overcome them. Similarly the man is helpless against other disasters.

Research in the field of science is continuing. New discoveries are added and field of knowledge is broadening day by day. If the current pace of research continues, tomorrow will be surely better than today.

### IMPORTANT POINTS

- Word science is derived from latin word “scientia” means regularly observing the facts.
- Ancient Greek philosophers were of the view that all things in the world are composed of four elements air, water, soil and fire.
- Jabir Bin Hayyan was the founder of chemistry. First time he prepared sulphuric acid, nitric acid and hydrochloric acid.
- Muhammad Bin Zikrya Al-Razi was a chemist, but he was also a medical practitioner.
- Ibn-ul-Haitham was a physicist. He invented pinhole camera.

- Al-Bairuni wrote 150 books on different topics of mathematics.
- Bu Ali Sina is considered “Aristotle of the muslim world”.
- Al-Qanoon-fil-Tib is an encyclopedia on “Tib” which consists of fourteen volumes.
- Dr. Abdus Salam is the only Noble prize winner scientist of Pakistan.
- Dr. Abdul Qadeer Khan alongwith other Pakistani scientists successfully tested the nuclear device at Chaghi in Balochistan on May 28, 1998.
- Dr. Munir Ahmad Khan remained the chairman of Atomic Energy Commission from January 20, 1972 to 1990.
- Dr. Atta-ur-Rehman worked as director in Hussain Jamal institute of chemistry. His services are highly appreciable in the field of medicine.
- Dr. Samar Mubarak Mand performed successfully nuclear experiments at Chaghai on May 28 and 30, 1998.
- Dr. Ashfaq Ahmad joined Pakistan Atomic Energy Commission in 1960 and was appointed as its Chairman in 1991.

## Glossary

- Technology:** Science of industrial art. Methods used by experts.
- Medicine:** Knowledge about diseases, their cure and pharmacy.
- Plants:** Living, growing thing other than animal, especially one with leaves, flowers, and roots, smaller than a tree.
- Astronomy:** Science of the sun, moon, planets and stars.
- Botany:** Study of plants.
- Zoology:** Study of animals.
- Geography:** Graph marking of different parts of the earth.

## Questions

Q:1 Fill in the blanks:

- Jabir Bin Hayyan was an expert in \_\_\_\_\_.
- The study of animals is called \_\_\_\_\_.

- iii. Bu Ali Sina is called \_\_\_\_\_ of the muslim world.
- iv. \_\_\_\_\_ divided chemical compounds into four categories namely, minerals, botanicals, animals and derived compounds.
- v. Muslim scientist \_\_\_\_\_ is considered as the pioneer in the field of chemistry.
- vi. “Kitab-ul-Manazir” is the first book on \_\_\_\_\_.

Q:2 Put the sign (✓) against the correct statement and the sign (✗) against the wrong statement.

- i. Bu Ali Sina was considered to be one of the founders of medicine.
- ii. Jabir Bin Hayyan was the first who discussed in detail the causes, symptoms, cure and prevention of smallpox and measles.
- iii. Jabir Bin Hayyan was an expert in physics.
- iv. “Kitab-ul-Manazir” is a publication of Al-Bairuni.
- v. The knowledge about animals is called botany.
- vi. In the life of animals and plants, many factors are common.

Q:3 Identify the correct answer and encircle it from the following statements.

- (i) Ibn-ul-Haitham is related to branch of science.
  - a. Sound
  - b. Heat
  - c. Light
  - d. Chemistry
- (ii) The name of famous book written by Al-Bairuni is:
  - a. Kitab-ul-Manazir
  - b. Al-Havi
  - c. Al-Shafa
  - d. Tahreer-ul-Amakin
- (iii) The branch of science related to mechanics, heat, light and sound is?
  - a. Geology
  - b. Astronomy
  - c. Chemistry
  - d. Physics

- Q: 4 What is meant by science?
- Q: 5 Write down the important branches of science. What do you know about each branch of science?
- Q: 6 Write down the names of two muslim scientists and give their important contribution to the service of science.
- Q: 7 Write down the names of a few Pakistani scientists and discuss their contributions.
- Q: 8 What are the limitations of science?
- Q: 9 What is meant by technology? Give some example of ancient technology.
- Q: 10. Define biology. Discuss that it is a branch of science.
- Q: 11 The importance of science and knowledge have been discussed in the Holy Quran. Write two verses of the Holy Quran to explain.
- Q: 12 What is physics? Write down the names of its important branches.

# 2 OUR LIFE AND CHEMISTRY

In this chapter you will learn:

- The building elements for life.
- Importance of carbon.
- An introduction to organic chemistry.
- Water and its properties.
- The role of different gases in air.
- Essential elements for life.

## 2.1 The Basic Building Elements for Life

In the body of living organisms, many elements are found in different quantities. In them carbon, hydrogen and oxygen have great importance. The human body also constitute these three elements. These elements combine to form organic compounds such as proteins, carbohydrates and lipids. All these compounds work as building material for the bodies of living organisms e.g. meat, pulses, fats, cooking oil, sugar, wheat etc.

### Carbon

Carbon is one of the essential part of all living things on this planet. Small quantities of carbon are found in the earth's crust as the free element. Carbon is an important element of natural compounds such as natural gas, petroleum and wood etc. Carbon is also present in the food you eat. The food containing carbon, hydrogen and oxygen are either carbohydrates (starch, sugar, cellulose) or fats (butter, oils) while the food containing carbon, hydrogen oxygen, and sulphur or nitrogen are proteins (meat, fish). All the plant life is also made up of compounds containing carbon, hydrogen and oxygen. Other carbon containing compounds are silk, soap, alcohol, plastic etc.

### Hydrogen

Hydrogen is an essential part of water ( $H_2O$ ) and therefore important for all living things. Other than this it is found in natural gas. It is most common element in the universe, for example the sun is a huge white-hot ball consisting almost entirely of hydrogen.

## Oxygen

Oxygen is a colourless, odourless gas which is slightly soluble in water. Fish and all form of aquatic life rely on this property. It is the major constituent of air. The various organic compounds containing oxygen are glucose, sugar, cellulose, fats, proteins etc.

## Importance of Carbon, Hydrogen and Oxygen

You have already studied that carbon, hydrogen and oxygen play important role in the living organisms. Respiration is a process which provides energy to the body while photosynthesis is a direct or indirect source of food for living beings. These three elements have basic role in these two processes.

## Respiration

Oxygen is essential for life. It plays an important role in respiration. Respiration is the process by which living things use oxygen from the air to oxidize food substances (mainly glucose) in their body cell.



When we breathe in, we take air into our lungs. The oxygen from the air then dissolves in the blood in our lungs. This dissolved oxygen is taken by hemoglobin to all parts of our body to react with glucose to produce energy. At the same time, carbon dioxide produced as a waste product is taken back to the lungs and breathed out.

## Photosynthesis

Photosynthesis is a process by which green plants manufacture carbohydrates (glucose) from atmospheric carbon dioxide and water from the soil, in the presence of energy of sunlight.

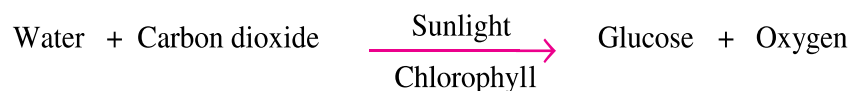

This process only occurs in chlorophyllous cells of the leaves and stems. Oxygen is produced in this process as a by-product and released into the atmosphere. Photosynthesis is effectively the reverse of respiration.

This is also called anabolic (building up) process while the respiration process is called catabolic (breaking down) process.

## 2.2 Carbon and its importance

Very small quantities of carbon are found in the earth crust as the free element. It is present in approximately one million known compounds. One of the unique property of carbon is that its atoms combine with each other to form long ring compounds.

### Allotropic Forms of Carbon:

Carbon exists in three different forms having different physical properties. When an element is found in more than one physical forms in the same state, it is called **allotropy** and such physical forms are called **allotropic forms**. Diamond, graphite and bucky balls are the allotropic forms of carbon. These allotropic forms have different physical properties such as appearance and density but they are the same element and have the same chemical properties.

#### (i) Diamond:

It is a colourless, transparent and crystalline form of carbon (Fig.2.1a) which is found in the earth under great heat and pressure. It is one of the hardest substance known, hence is used for tipping rock drills, in glass cutting, in polishing other precious stones.



(a) Diamond



(b) Graphite

Fig: 2.1 The Allotropic forms of Carbon



**(ii) Graphite:**

It is a second crystalline form of carbon (Fig. 2.1b) found in nature or made from coal by heating it in an electric furnace. It is a soft black solid which has shiny and a greasy feeling. It is used for the core of “lead pencils”, as a lubricant and in paints.

**(iii) Bucky Balls:**

Bucky balls is the third form of pure carbon known to exist naturally. It is used as a semi-conductor, conductors and lubricants.

**The Non-Allotropic forms of carbon.**

Charcoal and soot are also forms of carbon but they do not occur naturally. They are made by heating animal bones, wood, nut shell, sugar, blood or coal in a limited amount of air.

Coke is another form of carbon which is made by heating coal at about 1300°C in the absence of air. Charcoal is used for absorbing dangerous gases. It is also used by the artists. Coke is used as a fuel and as a reducing agent in various chemical industries.

**Interesting Information**

If a key is stiff in a lock, rub the end of the key with a soft pencil. This contains lots of graphite which will lubricate the movement of the key and hopefully, make the lock easier to open.



Fig: 2.2 Coke (The Non-Allotropic forms of carbon)

## 2.3 Organic Chemistry

Organic chemistry is the chemistry of compounds which contain the element carbon. Most of these compounds also contain hydrogen and many also contain oxygen or other element. There are a few compounds which contain carbon but are not classified as organic compounds. Carbon monoxide, carbon dioxide and the metal carbonates are examples.

## Types of Carbon Compounds

Carbon occurs in large number of naturally occurring compounds. e.g. natural gas (methane) and many of our fuels are compounds of carbon and hydrogen. Coal is a mixture of compound containing carbon, hydrogen and oxygen. There are many inorganic carbon compounds such as carbonates of sodium, calcium, and magnesium.

Carbon is also present in our food and every part of our body. All plant life is made up of compounds containing carbon, hydrogen and oxygen. In the atmosphere it is present in the form of carbon dioxide.



(a) Plastic



(b) Paints



(c) Medicines



(d) Carbohydrates containing food

Fig: 2.3 Types of Carbon compounds

Hydrocarbons are the simplest organic compounds. The molecules of hydrocarbons are made up of only two elements hydrogen and carbon. They occur naturally in fossil fuels, petroleum, coal and peat. The important class of naturally occurring organic compound is carbohydrates. The simplest form of carbohydrates is glucose. Other than

carbohydrates proteins, fats and oils are also very important organic compounds. The flesh of human beings, animals, birds and fishes are made of proteins.

Many of the organic compounds are made by man. They are artificial fibres, plastics, medicines, paints and many other things.

## 2.4 Water

Water is the common compound on earth. For instance, about four fifth of the earth's surface is covered with sea. It is the only chemical compound found naturally as a liquid, as a solid (ice) and as a gas (water vapours). Water plays a vital role in industry, in home and in laboratory and is also essential for life. About two thirds of the human body is water and many foods consist predominantly of water (Table 2.1)

### Interesting Information

Ethene gas can be used to help to ripen fruits specially bananas before they are sold. Crates of green bananas are left to ripen in special ripening rooms high in concentration of ethene gas.

**Table 2.1:** Water contents of some foods and living organs.

Food	% age of water by mass	Living organs	% age of water by mass
Tomatoes	95	Bones	22
Milk	87	Kidneys	82
Oranges	86	Blood	90
Apples	84	Egg	75
Potatoes	76		

### Properties of Water

Water is a clear colorless and odorless liquid. It has abnormal low freezing point ( $0^{\circ}\text{C}$ ) and high boiling point ( $100^{\circ}\text{C}$ ) at one atmospheric pressure.

Ice floats over water indicating that ice is lighter than water. In other words the density of ice is less than the density of water. As the temperature of ice rises the ice melts and its density increases. The density

### Interesting Information

The body of a young boys contains approximately 35 litres of water. This is over two thirds of the body weight. However, girls have very slightly less water per body weight. It is for this reason that certain medicines or drugs are faster acting on girls than on boys.

of water at 0°C is somewhere between 0.9990 g/cm<sup>3</sup> and 1.000 g/cm<sup>3</sup>, while the density of ice at 0°C is of the order 0.918 g/cm<sup>3</sup>. Therefore, there is considerable increase in volume when liquid changes to solid at 0°C. This is because that water molecules are less tightly packed (are at greater densities) in ice than in liquid water. The density of water is maximum at 4°C. The fact that water contracts on cooling from 0°C to 4°C is quite contrary of the behaviour of many of the other liquids. This property helps nature to preserve fish and other aquatic animals in winter in countries where freezing of water takes place during winter. When cooling of water starts, as winter approaches the density of water increases until it reaches its maximum (density 1.00 g/cm<sup>3</sup>) at 4°C. Thus water is heavier at 4°C and sinks to its bottom. Further cooling cools down the surface layer below 4°C and since the density of water now is lower than the water at 4°C stays at the top and frozen to solid ice, while the liquid below remains at 4°C.

The soluble air present in the water below the ice, helps animals to breath and thus they spend a nice winter under a thick blanket of ice.

### Water as Universal Solvent

One of the most interesting things about water is that it dissolves a variety of substances. It is therefore extensively used as a solvent in industrial chemical processes and also many chemical reactions are carried out in it. The solubilities of solids increase with increasing temperature. Different solutes have different solubilities at a particular temperature. For example at 50°C 100g of water will dissolve 84g of potassium nitrate but only 33g of copper sulphate.

Besides these, all gases can dissolve in water to some extent. Examples of such gases are oxygen, hydrogen, nitrogen and carbon dioxide. In general, the solubilities of gases decrease with an increase in the temperature. Water is also a universal solvent for biochemical reactions.

## 2.5 Air

The atmosphere surrounding our earth is a mixture of various gases. The percentage composition of air by volume is shown in table 2.2.

**Table 2.2:** Percentage composition of various gases in air

Component	Percentage composition by volume
Nitrogen	78
Oxygen	21
Argon	0.9
Carbon dioxide	0.03
Neon	0.002
Helium, Krypton and Xenon	0.00055

The composition of air remains approximately constant. For example, the composition of oxygen and carbon dioxide is kept constant by the process of photosynthesis and respiration respectively.

### Interesting Information

Each day a normal man breathe in 15,000 to 20,000 litres of air

## Role of Oxygen in Air

Oxygen is the second most abundant gas found in air after nitrogen. It is essential for supporting life and phenomena of burning and rusting. For burning or combustion, we require three things, fuel, heat and oxygen. These make up the three principles of fire-fighting, because in the absence of any one of these, the fire goes out.

Burning or combustion is a chemical process, which is accompanied by the production of light and heat. During this process, the combustible material usually combines with atmospheric oxygen to form oxides. This oxide form acid, when it is dissolved in water.

Degradation of all kinds of food like vegetable, meat etc., is because of the oxidation of organic materials present in it. Ozone is produced from oxygen which is present in the earth atmosphere, is useful to protect the living organisms, by absorbing ultraviolet light of the sun.

## Role of Nitrogen in Air

Nitrogen occur in the atmosphere as diatomic molecules. It is the major constituent of air. It is relatively inert, as compared to oxygen, but it acts as an important diluent of the air to slow down combustion and corrosion.

Nitrogen also occurs in plants and animals in the form of proteins. Animals obtain protein by consuming plants. Plants produces protein from the nitrate in the soil. Nitrates are produced from atmospheric nitrogen and ammonia present in soil. Plants get their nitrogen from nitrates present in soil. This nitrogen directly or indirectly reaches the animal. As dead plants and animals decay, some soluble nitrogen containing compounds, usually nitrates, are produced and can be absorbed by these plants. Some of these nitrates are converted into nitrogen by bacteria in the soil. This is then released back into the atmosphere. In nature the process in which nitrogen is transferred from living organisms to soil and from soil to living organisms regularly is called nitrogen cycle and this nitrogen cycle keeps the amount of nitrogen constant in air.

### Role of Carbon Dioxide in Air

The atmospheric air contains only approximately 0.03% by volume of carbon dioxide. This proportion is kept constant by a balance in nature between the process of photosynthesis, which remove carbon dioxide from the atmosphere, and those of respiration, decay and combustion which return it to the atmosphere. These processes are called carbon cycle.

Carbon dioxide also plays an important part in the air by absorbing infrared rays from the sun. Thus  $\text{CO}_2$  protects the living organisms from the harmful rays.

However, the problem will rise in the near future through the burning of too much carbon containing fuel. This could upset the balance of the carbon cycle by liberating too much carbon dioxide into the air. It is thought that if the amount of carbon dioxide increases in the air then the temperature of the earth will rise. This is called green house effect. The higher temperature would cause the ice on the mountains to melt and flooding to occur. Weather pattern on our planet would also be affected.

### Rare Gases and their uses

The atmosphere contains approximately 1% by volume of rare noble gases. These are characterized by their chemical inertness. Helium is very light gas, so it is used as an alternative to hydrogen in weather balloons.



(a) Argon containing bulb



(b) Neon in advertising sign



(c) Divers use mixture of helium and oxygen

Fig. 2.4 Some uses of rare gases



A mixture of helium (80%) and oxygen (20%) is used as an artificial atmosphere by divers. It is used instead of nitrogen as it is less soluble than nitrogen in blood to prevent the bends in high pressure work.

Neon glow red when electricity is passed through it and so it finds a use in advertising sign. Argon is used to fill electric light bulbs and various types of fluorescent and phototubes. Krypton is used to fill fluorescent lights and photographic flash lamps. Radon is used in the treatment of cancer.

Since the noble gases are extremely unreactive, they provide a useful inert atmosphere for some chemical reactions. These are also used in the electric welding of metals.

## 2.6 Important Elements for Life

Some elements are found to be essential (some in large, some in small quantities) for maintenance of our health, agriculture and daily life uses. We shall not attempt to cover all the elements known to be involved in above mentioned functions. Instead, we discuss only those that are presently recognized to be most important or about which most is known. Based on one or both of these criteria, the functions of some elements are discussed.

### (i) Iron

Iron is the second most abundant metal found in the earth's crust after aluminium. It has been known and used by mankind for a long time. Today, it is one of the best known metals in the world because of its very great economic and industrial importance. It is used for general engineering purposes such as corrugated sheets, car bodies, nails, screws, steel pipes, tools etc.

Iron is essential to all living organisms. It is present at the active centre of molecules (Hemoglobin and Myoglobin) responsible for oxygen carrier and of other types of molecules (cytochromes and Ferredoxins) for electron transport. Normally it is slightly toxic, but excessive intake can cause siderosis and damage to some organs.

The iron content in plant tissue is normally between 50-250 ppm. It is absorbed, by plant roots from the soil as  $\text{Fe}^{2+}$  and  $\text{Fe}^{3+}$ . These irons are involved in photosynthesis.

### (ii) Sodium

It is used in sodium vapour lamps (which gives a bright orange-yellow light), for street lighting. It is used for the preparation of important compounds such as sodium peroxide ( $\text{Na}_2\text{O}_2$ ), sodium cyanide ( $\text{NaCN}$ ) which is used in the extraction of gold. It is also used for the preparation of tetraethyl lead which is added in petrol as an anti-knocking agent.

Sodium is a major component of vertebrate blood plasma. It is important in different functions of living organisms. It is associated with some forms of hypertension in some individuals.

Sodium is absorbed by plants as  $Na^{+1}$  and its concentration varies widely from 0.01 to 10% in leaf tissue. It is essential for halophytic plant species that accumulate salts in vacuoles to maintain turgor and growth. Crops that require sodium for optimum growth include spinach, sugar beet, turnip etc.

### (iii) Potassium

Potassium in the form of carbonates is used in the preparation of glass and soap. One of its another compound potassium phosphate is used in preparation of detergents. Potassium nitrate is used in preparation of glass and explosive material.

It is an essential element for almost all living organisms. It plays an important role in nerve action and cardiac function. It is moderately toxic to mammals when injected intravenously otherwise harmless.

Potassium is absorbed by plant roots as  $K^{+}$ . The concentration of potassium in vegetative tissue usually ranges from 1 to 4% on a dry matter basis. Many plant enzymes require potassium for their activation.

### (iv) Magnesium

Because of its low density, Mg is used in preparing light but rough alloys such as magnalium (a mixture of aluminum and magnesium). These alloys are used for the construction of cars, aircrafts and moving parts of machines.

It is essential to all organisms. It is present in chlorophyll. It has electrochemical and enzyme activating functions.

Magnesium is absorbed as  $Mg^{2+}$  and its concentration in crops varies between 0.1 and 0.4%. The importance of  $Mg^{2+}$  is obvious since it is a primary constituent of chlorophyll molecule and without chlorophyll the autotrophic green plant would fail to carry on photosynthesis.

### (v) Calcium

This element is used as deoxidant in steel casting. It is used in extraction of uranium and in preparation of calcium fluorides and calcium hydrides.

It is an essential element for all organisms, it is used in cell walls, bones, and some shells as important compound. It is involved in blood clotting.

In plants calcium concentration ranges from 0.2 to 1%. It has an important role in the structure and permeability of cell membranes. Lack of  $Ca^{2+}$  produces a general breakdown of membrane structures.



**(vi) Phosphorous**

Phosphorous occurs in most plants in concentration between 0.1 and 0.4%. Plants absorb either  $\text{H}_2\text{PO}_4^-$  or  $\text{HPO}_4^-$  orthophosphate ions. The most essential function of phosphorous in plants is in energy storage and transfer. Adenosine di and tri-phosphates (ADP and ATP) act as “energy currency” within the plants. In human beings during carbohydrate metabolism and in plants during photosynthesis the energy produced is stored in the form of phosphate compounds i.e. ADP and ATP. When the phosphate compounds from either ATP or ADP is split off, a relatively large amount of energy (12,000) cal/mol) is liberated. This energy is used in growth and reproductive processes.

It is an important constituent of DNA (deoxyribonucleic acid) and RNA (ribonucleic acid), bones, teeth, some shells, membrane, phospholipids, Adenosine diphosphate (ADP) and Adenosine triphosphate (ATP).

This element is used in the form of superphosphate and tri-phosphate in fertilizers. Phosphoric acid and its salts are used in food industry, detergents and baking powders. Phosphorous is also used in matches .

**(vii) Fluorine**

Trace amounts of fluorine (2.5 ppm) in diet is essential for optimal growth and strengthens teeth in mammals.

Fluorine generally occurs in plant material in the range of 2-20 ppm in the dry matter, although some plant species are capable of accumulating much higher amounts. The high concentration of fluorine (i.e. 200 ppm) in plants is toxic to animal. It is neither required for plant's growth nor it play any essential role in plant metabolism

Some fluorides and other compounds of fluorine are used as a refrigerant, anaesthetic, non-stick agent insulator. Hydrofluoric acid is used in etching glass and in cleaning steel. Sodium fluoride in trace amount is used for the fluoridation of drinking water, while tin fluoride is used in many tooth pastes to protect the decay of tooth.

**(viii) Chlorine**

Although, the chlorine gas is very poisonous but it has many beneficial uses in daily life. It is used to kill germs and bacteria and is commonly used in domestic bleaches. It is also used in water purification and in swimming pools. Polyvinyl chloride is a common plastic compound of chlorine and is known as PVC. It has many uses, especially as an insulator or as a water proofing material.

It is an essential element for higher plants and mammals. Sodium salt of chloride ( $\text{NaCl}$ ) act as electrolyte and hydrochloric acid as digestive juices in body. Deficiency of chloride cause the impaired growth in infants.

Chlorine is essential for higher plants. It is present in chloroplasts which is essential for photosynthesis. Plants which take up large amount of  $\text{Cl}^{-1}$  usually have a high water content.

**(ix) Iodine:**

Iodine is used in making dyes for colour photography and pharmaceutical chemicals. A dilute solution of iodine in ethanol, which is known as tincture of iodine, is commonly used as an antiseptic.

It is essential element in many organisms. Low iodide availability in certain areas increases the incidence of goiter. Iodine – 131 is used to treat the thyroid.

Iodine has not been shown to be essential to plants but are reputed to produce stimulating effects on plant growth at low concentrations. In healthy plants the iodine level is 0.5 ppm. at higher concentrations.

### IMPORTANT POINTS

- Carbon, hydrogen and oxygen are the building elements for life.
- Oxygen and carbon dioxide are important for respiration and photosynthesis.
- Carbon exists in three allotropic forms diamond, graphite and bucky balls.
- Organic chemistry is the chemistry of compounds which contain carbon as essential element.
- Water is very common and important compound on earth. It is a universal solvent. It shows maximum density at  $4^{\circ}\text{C}$ .
- Ice floats on the surface of water due to lower density.
- Air is a mixture of various gases i.e. nitrogen, oxygen and carbon dioxide.
- Oxygen is necessary for burning, combustion and fire.
- Nitrogen is an essential element for proteins.
- Rare or noble gases are inert and are found in trace amount in air. They are used for different purposes.
- Different elements play very important role in biological systems, daily life and agriculture.

## GLOSSARY

- Carbohydrates:** These are the major class of naturally occurring organic compounds, which contain carbon, hydrogen and oxygen.
- Proteins:** These are the naturally occurring macromolecules which contain polymers of amino acids.
- Respiration:** It is the process by which living things use oxygen from the air to oxidize food substances.
- Photosynthesis:** It is a process by which green plants manufacture carbohydrates from atmospheric carbon dioxide and water from soil, in the presence of sun light.
- Allotropy:** When an element is found in more than one physical forms in the same state, it is called allotropy. Carbon is the most common example which exist in three allotropic forms diamond, graphite and bucky balls.
- Organic Chemistry:** It is the chemistry of compounds of carbon as an essential element.
- Nitrogen Cycle:** It is the process in which atmospheric nitrogen is converted into its compounds which then decomposes into nitrogen and goes back in the atmosphere.
- Rare gases** Those gases which are found in trace amount in atmosphere and are characterized by their inertness are called noble gases.

## QUESTIONS

### Q.1 Fill in the blanks:

- (i) \_\_\_\_\_ is the process by which plants produce glucose.
- (ii) The %age composition of the methane is about \_\_\_\_\_ in natural gas.
- (iii) \_\_\_\_\_ is the only chemical compound found naturally as a liquid as a solid, and as a gas.
- (iv) Nitrogen occurs in plants and animals in the form of \_\_\_\_\_.
- (v) Dilute solution of Iodine in ethanol is called \_\_\_\_\_.
- (vi) Phosphorous is an important constituent of \_\_\_\_\_.
- (vii) Carbon is an important \_\_\_\_\_ for all organisms

**Q.2 Choose the correct Answer**

- (i) The form of carbon which is not crystalline is .  
(a) Charcoal      (b) Graphite      (c) Bucky Ball      (d) Diamond
- (ii) The process of converting atmospheric nitrogen to useable form is called.  
(a) Nitrogen Cycle      (b) Carbon Cycle      (c) Nitrogen fixation      (d) Water cycle.
- (iii) Oxygen and nitrogen react to form  
(a) Nitric acid      (b) Nitrogen oxide      (c) Nitrogen peroxide      (d) Nitrate.
- (iv) The amount of carbon dioxide in the air is increased by  
(a) Photosynthesis      (b) Respiration      (c) Burning      (d) Evaporation
- (v) The deficiency of Iodine in human body cause.  
(a) Goiter      (b) Cancer      (c) Tuberculosis      (d) Cholera.
- (vi) The contents of sodium in leaf tissues vary from.  
(a) 0.01 – 10%      (b) 10–15%      (c) 16 –12%      (d) 16–20%

**Q.3 Short Questions:**

- (i) What is allotropy?
- (ii) Name those three elements which are abundantly found in human body.
- Q.4** Why do the water expands on freezing
- Q.5** Write the notes on (1) Water as universal solvent (2) Properties of water
- Q.6** Write the importance of any two elements found in air.

A decorative banner for Chapter 3. It features a large black number '3' on the left side, set against a background of light blue and green curved shapes. To the right of the number, the words 'BIOCHEMISTRY AND BIOTECHNOLOGY' are written in a bold, black, sans-serif font. The banner has a red border on the right and bottom edges.

# 3

## BIOCHEMISTRY AND BIOTECHNOLOGY

In this chapter you will learn:

- Definition of metabolism and explanation.
- Introduction to enzymes, their role in metabolism and our daily life.
- Composition of blood, its types and functions.
- DNA as a hereditary material
- Introduction to genetic engineering and its role in agriculture and live stock.
- Improvement of crops and disease control.
- Introduction to antibiotics and vaccines.
- Recycling of waste materials.

Biochemistry is a branch of chemistry which deals with all the chemical reactions taking place in living organisms like plants, animals, bacteria, etc. These chemical reactions can help in the synthesis (anabolism) or breakdown (catabolism) of biological molecules. The digested food become part of the body due to anabolic reactions while respiration is a simple catabolic reaction. Its knowledge has been used to produce a large number of material for the benefits of human beings. The term biotechnology was introduced in 1970. The techniques of biotechnology can be used to alter the genetic make up of microscopic organisms to produce useful materials like enzymes and hormones etc.

### 3.1 Metabolism

A large number of chemical reactions take place in animal and plant cells and cells of biological organisms which are collectively called **metabolism**. Metabolism consists of two types of reactions which can either synthesize molecules (anabolic reactions) or break the complex molecules. Catabolism is a catabolic reaction in the result of which the complex organic molecules are broken down into simple molecules. Catabolic reactions release energy. This energy can be used in several biological processes.

In the result of catabolic reactions carbohydrates, proteins and lipids are broken down and oxidized with the help of various enzymes. These reactions release energy which is used to perform many activities in the animals. Anabolism is a synthesizing process and the production of carbohydrates is one of its example in which plants use sunlight, carbon dioxide and water. This process is called photosynthesis.

The sum of all energy using and energy releasing reactions is called **metabolism**.

### Digestion and Assimilation

Digestion is a process which breaks down large food particles into smaller molecules. These smaller molecules can then be absorbed by cells for synthetic purposes which is called **assimilation**.

Digestion of food is necessary to split the macromolecules like carbohydrates, proteins and fats into simple molecules. These are necessary to be used by organisms to build new compounds. After this the products of digested material is absorbed by the cells of animals and are used either to produce new protoplasm or to provide energy.

### Carbohydrate Metabolism

Wheat, rice, corn, maize are the best sources of carbohydrates. The end products of carbohydrate are simple sugars like glucose, fructose and galactose. One gram of carbohydrate can supply 3.8k calories of energy. The carbohydrates are the cheapest source of diet which provide us the required energy. Excess carbohydrates are converted to glycogen and are stored in muscles and liver.

### Fat Metabolism

There are two sources of fats. We can obtain animal fat from butter oil (ghee) butter or cream, fatty meat and fish oil. The other source of fats is plants like sarson (brassica), olive, coconut, maize, soya bean, cotton seed, sunflower and peanut. Fats are made up of glycerol and fatty acids. They are digested and absorbed by small intestine. Excess fats may be stored in the adipose (fat storing) tissues of the body. During glucose deficiency or starvation, fats are used in respiration in place of glucose.

### Protein Metabolism:

Digestion of protein starts in the stomach. Undigested protein is digested by an enzyme and is converted into amino acids. These amino acids can be used for the synthesis of new proteins or oxidized to provide energy to the body. Other than this during the deficiency of carbohydrates, proteins are the effective source of energy.

## 3.2 Enzymes:

Enzymes are biological catalysts. A catalyst is a substance which can change or speed up a chemical reaction. Enzymes catalyze biochemical reaction and are protein in chemical structure. Enzymes speed up different catabolic and anabolic reactions.

Enzymes are required in very small amounts. They are very specific in their reaction. For example, amylase acts on starch but not on proteins or fats. The substances on which the enzymes act are called **substrates**. The specificity of an enzyme is due to its shape.

Some enzymes need other compounds to complete catabolic reactions. These are called **coenzymes**. Coenzymes are non protein substances.

### Role of Enzymes in our Daily Life

Enzymes play an important role in our daily life. They are useful in industry. Enzymes are used in chemical and pharmaceutical industry. They are used in cheese production. Enzymes are commonly used in food processing industry. The enzyme papain is obtained from papaya and is used as a meat tenderizer.

## 3.3 Blood and its Functions

Blood is the most important fluid of human body. It transports digested food and oxygen to the cells of all parts of the body. It brings back the useless products of metabolism into kidneys and liver. Blood is a very complex fluid. It consists of a liquid blood plasma in which blood cells are suspended.

Red blood cells, (erythrocytes) white blood cells (leucocytes) and platelets float in the plasma. The fluid part of blood with out blood cells is called **plasma**. If we remove blood clotting protein (fibrinogen ) from plasma then the remaining fluid is called **serum**. The blood cells are helpful in transport of gases, white blood cells control body immunity system and blood platelets are helpful in blood clotting.

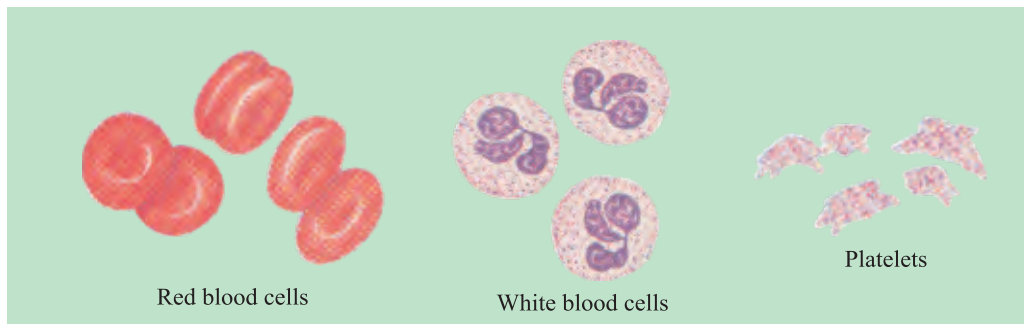

Fig. 3.1 Blood Cells

### Blood Groups

Human blood appears simply same but chemically people have different types of blood . This difference is based on antigen present on the surface of red blood cells. The human blood is divided into A, B, AB, and O groups on the basis of antigens and antibodies and is called **ABO system** of blood.

If a certain person belongs to A group of blood then this is due to the A antigens present on the surface of red blood cells. If another person's red blood cells have B

Landsteiner in 1902 divided human population in four groups on the basis of blood groups

antigens then he belongs to B group. Type AB individuals have both A and B antigens. Type O individuals are known as universal donor because their blood cells carry neither A nor B antigens. They can donate their blood to any person. Type AB individuals are universal recipients because their red cells have both antigens and they can receive blood from any individual.

**Table 3.1** Characteristics of ABO Blood groups

Blood Group	Antigens on RBCs	Type of antibodies in plasma	Donor	Recipients
A	A	B	A, O	A, AB
B	B	A	B,O	B, AB
AB	AB	None	A,B,AB,O	AB
O	None	AB	O	A, B, AB, O

There is a second blood group system called **Rh system**. It is based on another red blood cell antigen called the **Rh factor**. A can be Rh-positive or Rh-negative depending on the presence or absence of Rh factor. A pregnant Rh-negative mother cannot receive Rh-Positive blood because it can harm unborn Rh-Positive blood (inherited from father). It is dangerous and the mother is injected with anti Rh antibodies after delivering her first Rh-Positive body.

**Table 3.2** Rh-Factor System

Blood of the type of Rh-factor	Type of antigens or RBCs	Type of antibodies in Plasma	Matching Recipients	Matching Donors
Rh <sup>+</sup>	Rh <sup>+</sup>	Rh <sup>+</sup>	Rh <sup>+</sup> , Rh <sup>-</sup>	Rh <sup>+</sup>
Rh <sup>-</sup>	None	None	Rh <sup>-</sup>	Rh <sup>-</sup> , Rh <sup>+</sup>

### 3.4 DNA as Hereditary

The information for hereditary characters of a person are present in his genes. These genes are made up of a chemical compound called **DNA** or deoxy ribose nucleic acid and are part of the chromosomes located in the cell nucleus. DNA is made up of building blocks or units called **nucleotides**. Nucleotides are composed of a base, sugar and a phosphate group. These nucleotides are present in pairs and form double helical molecule called DNA.

The special parts of DNA has coded information and these parts are called **genes**. The bases are specifically arranged on DNA.

When a DNA molecule produces another molecule like itself then this process is called **DNA replication**.

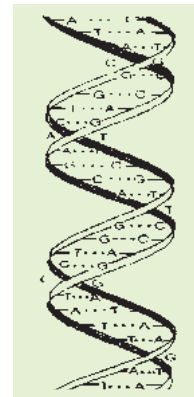
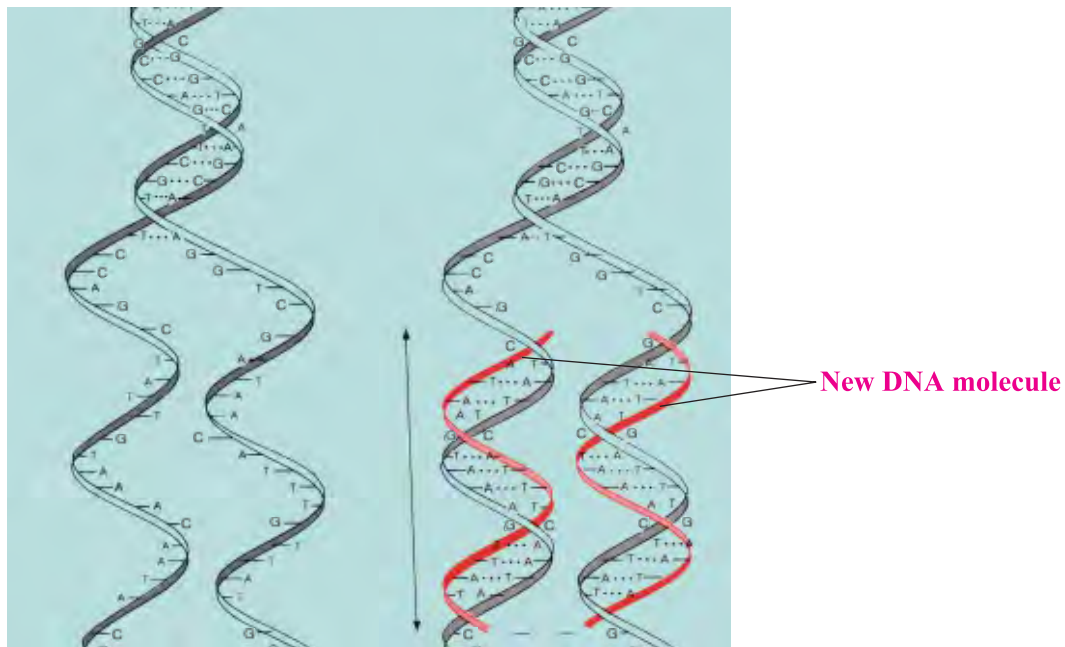

Fig. 3.2 DNA molecule



DNA is present in all the biological organisms. A child receives its DNA from both the parents. The characters of an individual, for example, skin colour, height, fitness, etc. are transferred to its offspring inheritedly. The defects in DNA are responsible for certain diseases like diabetes and haemophilia which are transmitted from parents to their offspring.

A set of all the genes in a cell is called **genome**. Human genome consists of 3.2 billion DNA letters or base pairs. The map or nucleotide sequence of 99.9 percent of human genome has been completed. This information is very important for medical science.



(a) Opening of DNA molecule

(b) Formation of new DNA molecule

Fig. 3.3: Replication of DNA

### 3.5 Genetic Engineering

Genetic engineering is a set of techniques used to transfer genes from one organism to another. Individual genes can be cut off from the cells of one organism and inserted into the cells of another. The genes from different sources can be combined in a test tube and then transferred into living cells. This technique is called **genetic engineering**.

#### Role of Genetic Engineering in Human Welfare

Any organism which receive a foreign gene is called a **transgenic organism**. Following are the steps for the production of genetically engineered organism.

- i) Identification of the gene of interest.
- ii) Removal of the gene from the donor.
- iii) Conversion of the gene into chromosome or DNA.
- iv) Introduction of the desired gene-carrying into the receipient.

## Significance of Genetic Engineering in Agriculture and Livestock.

Genetic engineering has revolutionized the agriculture which is apparent from the following examples.

- i) Production of high yield crop varieties and animals (milk and meat production)
- ii) Improvement in the nutritional quality of edible parts of plants.
- iii) Introduction of herbicide (weed killing chemicals), pesticide (insect killing chemical)
- iv) Increase in the shelf-life of fruits and vegetables
- v) Transfer of nitrogen-fixing genes into non-legumes (wheat, rice, etc)
- vi) Improvement in fruit quality.

### 1) Production of high yield crops

We can use the techniques of biotechnology to obtain genetically modified (GM) varieties of plants. It has been observed that most of the high yield crops or fruit trees are quite susceptible to diseases. It is quite desirable to introduce the disease resistant genes into high yield disease check plants.

### 2) Production of high yield animals

It is desirable to produce high milk and meat producing animals to feed the constantly increasing human population. A normal breeding programme in animal is quite lengthy. Biotechnology techniques can not only shorten the time for the production of desirable breed but also controls the diseases caused by crossing the closely related animals.

The cloning or the production of genetically similar individuals has already been carried out for sheep. This technique can be used for the production of animal organs in future.



Fig. 3.4: Genetically engineered sheep (Dolly)

## 3.6 The Role of Biotechnology in Betterment of Crops

### 1. Weed killing ability

Herbicides are the chemicals which are used to control the weeds or unwanted plants growing in crops. Sometimes these herbicides also affect the crop besides killing the weeds. A weak solution of cyanamide kills weeds, but is also causes some damage to tobacco plants.

Such genes are transferred in the tobacco plant due to which the plant not only shows resistance against herbicide but also gets advantage in their growth.

## 2. Pest resistance

BT gene, can induce pest resistance in plants. This gene has been introduced in cotton and the crop has become resistant to the attack of the insects. In 2002-2003 wheat season, the insects called aphids damaged the wheat crop on some parts of Sindh province. A huge amount of expensive pesticides were used to control aphid. This problem can be solved by producing aphid resistant varieties with the help of genetic engineering techniques.

## 3. Improvement of crop yield

Classical techniques of plants breeding require several years and large amount of money for the production of new high yield crops. Through genetic engineering in a short time, high yield crops are produced.

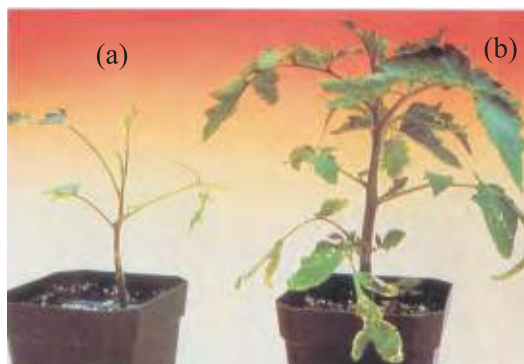

(a) The non-engineered tomato plant that has been completely eaten by caterpillar.

(b) The engineered tomato plant that is not affected by caterpillar.

Fig. 3.6: A successful experiment in pest resistance

## 3.7 Antibiotics and Vaccines

Compounds that inhibit the growth or kill bacteria are called antibiotics. There are millions of antibiotics, produced mainly from soil bacteria and fungi but only a few are used to control human bacterial diseases. They do not have any bad effect on humans and can not harm viruses.

Penicillins, tetracyclines, erythromycin etc. are some example of antibiotics.

### 1. Penicillins

Penicillins are made by a fungus called *Penicillium*. These attack a fairly narrow range of bacteria and are therefore called narrow spectrum antibiotics. Penicillin was discovered by Sir Alexander Fleming and Howard Florey in 1928.

### 2. Cephalosporins

These antibiotics are obtained from fungus *Manlosporium* and were discovered in 1948. These antibiotics are effective against bacteria which have developed resistance against penicillin.

### 3. Tetracyclines

Tetracyclines are made by the *Streptomyces* bacteria. They are effective against a variety of bacteria. Hence they are called broad spectrum antibiotics.

### 4. Erythromycines

They work against the same type of bacteria which have developed resistance against penicillin.

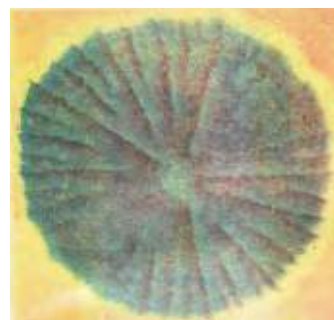

Fig. 3.7: Penicillin

Antibiotics work in two ways. Penicillin prevents the bacteria from forming cell wall which makes body's immunity system to destroy. Tetracycline on the other hand damage the protein producing machinery of bacterium. They prevent bacteria from dividing and inhibits their growth.

### Vaccines

Vaccines are harmless form of disease causing microbes that stimulate the immune system. The term vaccine is derived from vacca the Latin for cow. The first vaccine against small pox consisted of cow pox virus in the late 1700s. Edward Jenner an English physician learned from his patients that people who had contacted cow pox were resistant to subsequent small pox infections, in 1796. Jenner scratched a farm boy with needle bearing fluid from a sore of a milk maid who has cow pox. When the boy was later exposed to small pox, he resisted the disease. Vaccination stimulates the body's immune system.

## 3.8 Recycling of Waste and Scarce Materials

**Recycling** is the retrieval and reuse of waste materials for manufacturing purposes. A large number of solid wastes like iron, glass, plastic and rubber can be recovered and made reusable. Recycling is important for:

(1) Reduction in rubbish to control environmental pollution. (2) Conservation of raw materials and natural resources. (3) Treatment of sewage saves water which is scarce in many parts of world. (4) Recycling saves energy and money.

Many of the materials discarded as rubbish, such as paper, card board, plastic, rubber, metal glass etc. can be retrieved and recycled through respective industries.

We have to conserve the natural resources so that the environmental pollution could be controlled. A large amount of domestic and industrial rubbish is dumped as waste. Many of the discarded materials are valuable, which could be recycled and used. For example news papers, paper bags, card board boxes, if thrown away, represent a loss of materials. More trees would have to be cut down to make papers. This would result in deforestation. By reusing waste materials, recycling helps to reduce the problem of solid waste disposal. The recycling of solid



Fig. 3.7: Recycling (Production of new bottles from old one)

wastes means that there is less rubbish to be burnt. Many industries produce wastes that contain metals. Recovery of these metals from the wastes not only helps to conserve the metal but also reduce environmental pollution.

Recycling of sewage wastes through treatment can make it reusable. This is important in those parts of the world where water is very scarce. Sewage, if untreated, represents a loss of water. Untreated sewage also pollutes streams, rivers and lakes. This makes the water unfit for human consumption. In urban areas sewage can be treated in sewage tank. The purified effluent water is then discharged into rivers, streams or lakes, such water may flow into reservoirs, and later be treated and used for human consumption.

Recycling of waste materials can save energy and money. Some household rubbish, e.g. paper can be burnt to provide energy for domestic purposes. This can be done to provide heat for hot water and central heating system.

Broken glass bottles, cup, jars can be crushed and recycled. The use of crushed glass to make new containers saves materials. The energy and cost is reduced as this process uses less fuel.

Similarly, the recycling of aluminium cans and bottle caps can save materials, energy and money.

Organic manure and heat energy are the more practical things which we can obtain from recycling of waste materials. Some developed countries are trying to generate electricity by burning rubbish.

### Disposal of rubbish.

There are three methods for waste disposal in developed countries.

- (i) Compost of natural fertilizer
- (ii) Burning in incinerators
- (iii) To bury underground according to methods of hygiene.

## IMPORTANT POINTS

- Human diet mainly consists of important organic compounds like protein, carbohydrates and fats.
- In living organism different chemical reactions take place which are collectively called metabolism.
- Macromolecules are broken down to monomers during digestion.
- The end products of carbohydrate digestion are glucose, fructose and galactose.
- Fats are digested and absorbed in small intestine.
- Protein are digested in intestine and finally converts into amino acids.
- Enzymes work as catalysts in biological reactions.
- Blood consists of two parts called plasma and blood cells.
- DNA is the abbreviation for deoxyribose nucleic acid and it consists of sub units called nucleotides.
- Diabetes and haemophilia occur due to changes in DNA molecule.
- Penicillin is obtained from the fungus called penicillium.
- Gene is the basic unit of genetic information. These are small parts of DNA present in the chromosome



## GLOSSARY

<b>Biochemistry:</b>	The study of biochemical reactions in living organisms.
<b>Maltose :</b>	It is a disaccharide sugar produced by the digestion of starch.
<b>Catalyst.</b>	Change the speed of chemical reaction without undergoing any chemical change in structure.
<b>Genome :</b>	All the genes present in a cell.
<b>Genetic engineering:</b>	A technique to transfer genes from one organism to another.
<b>Antibiotics :</b>	Chemical compounds obtained from microorganisms and used to control infectious diseases caused by bacteria.
<b>Fatty Acids :</b>	Organic acids having hydrocarbon chain and released on hydrolysis of fats.
<b>Recycling :</b>	To produce new products from useless wastes or rubbish.

## QUESTIONS

1. **Fill in the blanks.**
  - (i) Penicillins are made by a fungus called \_\_\_\_\_.
  - (ii) Human blood can be classified into A,B, AB and O groups on the bases of antigen and \_\_\_\_\_.
  - (iii) Diabetes and haemophilia are due to change in \_\_\_\_\_ molecule.
  - (iv) The products of fat digestion are called\_\_\_\_\_.
  - (v) Cephalosporins are obtained from fungus \_\_\_\_\_.
2. **Put a ( ✓ ) against right question and ( ✗ ) against wrong question.**
  - (i) Metabolism is a combination of anabolic and catabolic reaction.
  - (ii) Fats are stored in the epithelial cells of human body.
  - (iii) Penicillin is a broad spectrum antibiotic .
3. **Each of the following question has four answers. Encircle the right answer.**
  - (i) The function of platelets is
 

(a) Blood Clotting	(b) Engulfing the bacteria
(c) To produce antibiotics	(d) Transfer of oxygen
  - (ii) Genetic information is transferred by
 

(a) Nucleus	(b) Chromosomes
(c) Genes	(d) Gametes
  - (iii) Fats are formed by the combination of
 

(a) Glucose + glucose	(b) Water + carbondioxide
(c) Glycerol + fatty acids.	(d) Amino Acids water
  - (iv) Penicillins was discovered by
 

(a) Robert Brown	(b) Sir Alexander Fleming and Howard Florey
(c) Edward Jenner	(d) Robert Hooke.
  - (v) The antibiotic cephalosporin was discovered in
 

(a) 1848	(b) 1948	(c) 1928	(d) 1998
----------	----------	----------	----------

4. Write brief answers.
- (i) Write the names of three main types of cells in blood ?
  - (ii) Which tissues store fats in human body?
  - (iii) What is transgenic organism?
  - (iv) What is a catalyst?
5. What is metabolism? Explain its different types.
6. What is meant by digestion and assimilation of food.
7. What is an enzyme? What role is played by enzymes in our daily life?
8. What are the components of blood?
9. How is DNA the hereditary material ? Explain in detail.
10. What is genetic engineering? How can it help in improving agriculture and livestock?
11. What is an antibiotic? Write down its types.
12. What is recycling? Give a detailed account how the waste and scarce materials can be made useable.



# 4 HUMAN HEALTH

## In this chapter you will learn:

- Introduction to important components of our diet like proteins, carbohydrates, fats, vitamins, minerals and water.
- To determine food and energy needs with respect to age, sex, climate, and physiological condition of the body.
- Importance of balanced diet for people belonging to different age groups.
- Definition and explanation of nervous system with respect to endocrine glands.
- Brief introduction to various stages and related problems of human life.
- Importance of exercise in human life.
- Use of first aid.

The health is wealth and a great gift from God Almighty. Human health not only depends upon the type of the food we take in but also on the fact whether a man is acquainted of all the phenomenon occurring in its body. Only after having a comprehensive knowledge of all these facts he can be successful to maintain his health. In this chapter, we shall not only discuss the role of diet to maintain the human health but we shall also try to investigate both intrinsic and extrinsic factors that influence human health and how a man can cope with all these challenges.

## 4.1 Food and its Major Components

Food is the basic necessity of human life. Scientifically speaking food is any thing which after digestion provides energy to the body for various activities and also helps in its growth and development.

### Water

Water is utmost important for life. A man can survive without food for at least a month but just for a few days without water. It is the most important component of human body, it makes almost 60% of an adult body weight. Water performs a number of very important functions in human body. It helps to maintain our body temperature. It acts as a medium for various chemical reaction in body. It helps in the metabolism of various substances in the presence of enzymes in the intracellular environment. It transports the nutrients to the cells and helps in the excretion of wastes of body. It acts as a lubricant in the joints and other internal body organs.



## Carbohydrates

They occur abundantly in all the living organisms and in almost all the cells. Cellulose of wood, cotton and paper, starch present in muscles of animals, lactose of milk and sucrose of cane are all examples of carbohydrates.

They play an important structural and functional role in living organisms. They are the primary source of energy for the cell. Wheat, rice, pulses, sugarcane, potato and beat are major sources.

## Fats

Lipids are classified as fats and oils. Fats are solid while oils are liquids at room temperature. Fats are obtained from animals while oils are produced from plants. The lipids are formed by the chemical combination of fatty acids with glycerol.

Butter, cream, corn oil, ghee are the examples of lipids. Fats provide a large amount of energy to our body as compared to carbohydrates and proteins. They provide the body with fat soluble vitamins. They accumulate below the skin and help to conserve the body heat. In addition they also protect the vital organs of our body such as heart, liver, kidney from mechanical injuries.

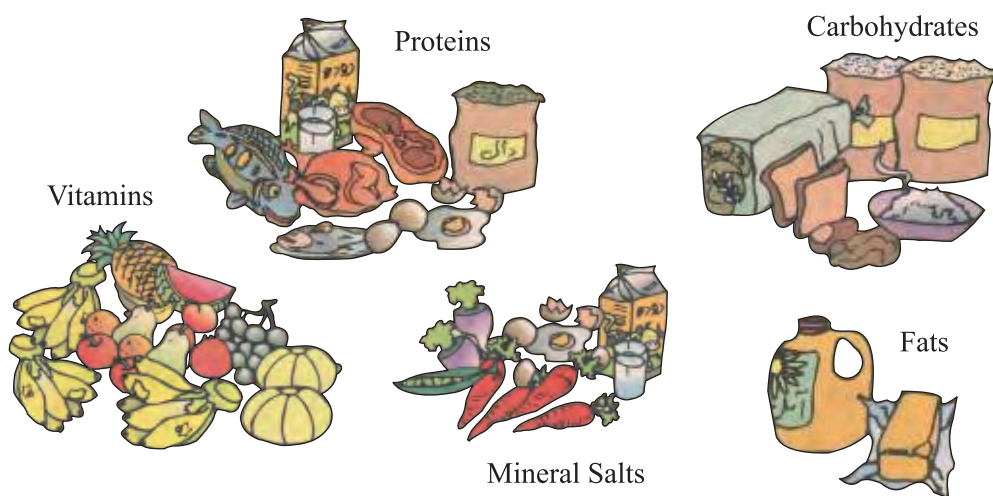

## Proteins

After water, the proteins are the most abundant of all the chemical substances in the body. The muscles, tissues and blood all are made up of proteins. They perform such important functions in body which would otherwise be impossible to occur. These are the large complex molecules made up by the condensation of amino acids that are the building blocks of proteins molecules.

They can be obtained from both plants and animals. Milk, egg, meat, fish are the animal sources of proteins whereas wheat, beans, pulses etc are its botanical sources.

All the proteins are made up of twenty different types of amino acids.

Proteins act as enzymes to catalyze various chemical reactions of the body. They act as hormone and bring about coordination in various physiological activities of the body.

They defend the body against various diseases by producing antibodies and so induce an immune response. They also help in transporting various materials from one part of the body to the other e.g. hemoglobin.

## Vitamins

These are the organic substances which are needed in the body in fractions only. They act as coenzymes in most of chemical reactions in the body. The body cannot grow normally if they are not taken in regularly. They can be divided into two groups.

1. Fat Soluble Vitamins (A,D,E,K)
2. Water Soluble Vitamins (B,C)

### Fat Soluble Vitamins

**Vitamin A:** It is found in abundance in the green leafy vegetables. It is present in large concentration in carrot, spinach, pea, cabbage and tomatoes. In addition, it is also present in wheat, corn, cream, butter, cod liver oil and liver of other animals. It helps to control the cellular metabolism and body growth. Vitamin A deficiency results in night blindness. The patients suffering from this disease are unable to see at night. Its deficiency also retards the growth in children. It may also cause various skin and dental diseases.

**Vitamin D:** Sun is the cheapest source of this vitamin. Human skin has the ability to synthesize this vitamin in the presence of sunlight. In addition, It may also be obtained from fish liver oil, milk butter, cream and egg yolk. Presence of proper amount of this vitamin in our daily diet promotes bone formation and calcium absorption in our body. Its deficiency results in softening, weakening and deforming of bones. Its deficiency in childhood causes rickets while in adulthood its deficiency results in osteomalacia.

**Vitamin E:** This vitamin can be obtained from seeds, wheat and egg. It can also be obtained from green leafy vegetables. Deficiency of vitamin E in the blood leads to serious muscular and nervous disorders. Its deficiency may also lead to infertility.

**Vitamin K:** It can be obtained from spinach and other green leafy vegetables. It is also found in meat in small quantities. This vitamin is helpful in blood clotting.

Deficiency of vitamin K slows down the blood clotting mechanism.

### Water Soluble Vitamins

**Vitamin B:** Vitamin B is the name of a group of various chemical compounds that is why it is known as vitamin B complex. It includes such vitamins as B<sub>1</sub>, B<sub>2</sub>, B<sub>6</sub> and B<sub>12</sub>.

**Vitamin B<sub>1</sub>:** It can be obtained from wheat. It is also present in vegetables, almond and pistachu. Its deficiency in diet leads to weakness of muscles causing a disease known as beriberi.

**Vitamin B<sub>2</sub>:** It can be obtained from diets full of cream butter, eggs and milk. Other than this they are found in liver, heart and kidney in large quantities. It is also found in meat and wheat. Deficiency of this vitamin leads to deficiency of blood causing a disease known as pernicious anemia. This vitamin is also needed for better digestion and proper functioning of nervous system. It also helps to synthesize hemoglobin. Deficiency of vitamin B<sub>2</sub> affects the growth of the children.

**Vitamin B<sub>12</sub>:** It is obtained from milk, eggs and liver.

**Vitamin C:** It can be obtained from fresh citrus fruits like oranges, grape fruit and lemon. In addition it can also be obtained from banana, guava and other fruits. It is also found in tomatoes and other vegetables. Vitamin C deficiency lead to a disease known as scurvy.

## Mineral Salts

In addition to organic compounds, our body also requires some inorganic compounds to maintain its proper functioning. These inorganic compounds are obtained from mineral elements present in our food and include calcium, iron, iodine, fluorine, magnesium and phosphorus. They perform a number of important functions in our body. Some of their functions are described below:

1. **Calcium** plays a vital role in blood clotting, transmission of impulses, contraction and relaxation of muscles and formation of bones.
2. **Iron** is a part of hemoglobin which is a transport protein and helps in the transport of oxygen to all the body cells. Deficiency of iron leads to anemia.
3. **Iodine** is required for the synthesis of thyroxine in the thyroid gland. Deficiency of it causes goiter and retards mental growth.
4. **Sodium** and **potassium** play very important role in generating nerve impulse. Sodium and chloride control different functions of body.
5. **Fluorides** are essential for healthy development of teeth.

## 4.2 Food and Energy

Energy is needed to maintain our daily activities, to maintain body temperature, to control all metabolic activities and for enhancing growth. Energy is produced from various food components such as carbohydrates, fats and proteins. The energy obtained from food is measured in terms of calories. Calorie is the unit of energy.

**The amount of energy in different food components:** Different food components provide different amount of energy to body. For example one gram of carbohydrates gives 4.1 Kcalories whereas the same amount of fats give approximately the double amount of energy i.e. 9.3 Kcalories. Different food sources give different amounts of energy. The table 4.1 shows the amount of energy present in various food items.

**Table 4.1:** The amount of energy in different food items

Food items	Kilo Calories/100 gm
Rice	348
Wheat	348
Pea	109
Potato	99
Brinjal	5
Cucumber	14
Banana	153
Dry fruits	655-549
Cow milk	65
Buffalo milk	117
Egg	180
Meat	194

**Table 4.2:** The amount of energy required by the people of different ages

Children age in years	Required Kilo calories	Men & Women	Required Kilo calories
1-3	1200	Women who do not work	2090
4-6	1600	Women doing hard work	3000
7-9	2000	Men who do not work	3400
10-12	2500	Men doing hard work	4500

Energy needs of a man depend on many factors. Most important of these factors are the rate of basal metabolism, body weight, sex, age, climatic condition and physiological condition.

Children need more energy than adults or old people. Old people need energy only for their repair and maintenance whereas children need energy not only for their repair and maintenance but for rapid growth and to cope the challenges of puberty. They have higher metabolic and growth rates than old people that's why they need more energy per kilogram of their body weight.

Men need more energy than women. Similarly, men who are actively engaged in physical hardwork need more energy than those who are not involved in physical labour.

Pregnant and lactating women need more energy than their normal counter parts. They require energy not only for themselves but also for their developing babies.

People living in hot climate need less energy to maintain their body temperature than those living in colder regions of the world. Normal body temperature of human beings is 37<sup>0</sup>C, so more energy is required to maintain this constant temperature in cold climates or in colder months of the year.

### 4.3 Balanced Diet

Dietetics always emphasize to use a balanced diet but most of us are unaware of the exact definition of balanced diet. A balanced diet is one that contains well proportionate quantity of all the macro and micronutrients according to our body demands in such a way that neither any nutrient is in excess nor is deficient. A balanced diet maintains our health in such a way that we neither loose weight nor become overweight. A balanced diet varies according to the caloric needs of a person whereas the caloric needs depend on the weight, age, sex, body physiology and working condition of that person.

#### Diet for Infants

Milk is the best food for babies that contains all the necessary nutrients therefore breast feeding is matchless. It provides not only the nutrients but also the prepared antibodies to the infants. But if breast feeding is not possible under certain unavoidable circumstances then cow or buffalo milk can also be used. It is necessary to dilute it by adding two parts of water against one part of cow or buffalo milk. They can also be served with light solid foods such as cereals, egg yolk or boiled minced meat after fourth month of their life. Infants between 6 to 18 months should be given fruits and eggs in addition to milk.

#### Diet for Youngs:

They need more food as they are more active and agile. Their diet should have higher content of carbohydrate and fatty foods. As the young body is passing through rapid growth phase, they also need high protein diet. Balanced diet should strictly be administered between the age of 13-16 years. Milk and milk products should be an integral part of their food.

**Diet for Old:**

They require less energy than the above two categories for diminishing physical faculties. They should not use diets with higher fat contents. Instead they should take diet having moderate amount of proteins and carbohydrates.

**Diet for Pregnant and Lactating Women**

They need double the amount of food than an ordinary women as they have to fulfill the requirement of the developing embryo. If they do not take a well balanced diet, the development of the body may be affected and they will be born under weight. The pregnant women should therefore, take a balanced diet with high protein profile, vitamins and minerals. Lactating women should also use milk, sugar, fats, wheat, fruits and eggs regarding so that they should fulfill energy demands of their breast-feeding offspring.

## 4.4 Coordination and Integration in Body Functions

All the living organisms are bestowed with some common characteristics. One of them is to respond the stimulus. Whether the stimuli are extrinsic or intrinsic, at cell, tissue, organ or body level. Coordination and integration in various human body functions to respond to these stimuli is of extreme importance.

The coordination and integration in human body is brought about by two systems. One of these is nervous system while the other is endocrine system. Nervous system consists of brain, spinal cord and two types of nerves. These nerves interpret the internal and external stimuli and show suitable response. In addition to showing response they also coordinate between different organs. Endocrine system comprises of ductless glands which secrete secretions known as hormones. These glands also receive the internal and external stimuli through nervous system and secrete hormones. These hormones are helpful in coordinating the functions of different organs and also show response. The hormones are the chemical messengers that are transported from their site of synthesis to their site of action through blood and bring about coordination in body functions.

**Endocrine glands**

Following endocrine glands are present in our body.

**Pituitary Gland**

It is a small gland equal to the size of pea. It is attached to the brain. As this gland controls the activities of all other glands, it is also known as “Master gland”. This gland controls the growth and many activities of the body.

**Thyroid Gland**

It is situated in the neck region on the front of trachea. It secretes two types of hormones. The hormone thyroxine needs iodine for its secretion. These hormones bring normal body growth and control calcium level in blood. The deficiency of iodine causes thyroid to increase in size than normal and results in goiter.

**Adrenal Glands**

These glands are in the form of a pair, each member lying above the upper end of kidney. Both parts secrete different hormones. The hormones of adrenal cortex control glucose level in the blood and maintain balance in the sodium and water concentration in the body. The hormones of adrenal medulla control the involuntary actions of the body. They prepare the human body to face emergency situations like fear, light or sorrow. They increase heart beat and metabolic rate of human body.



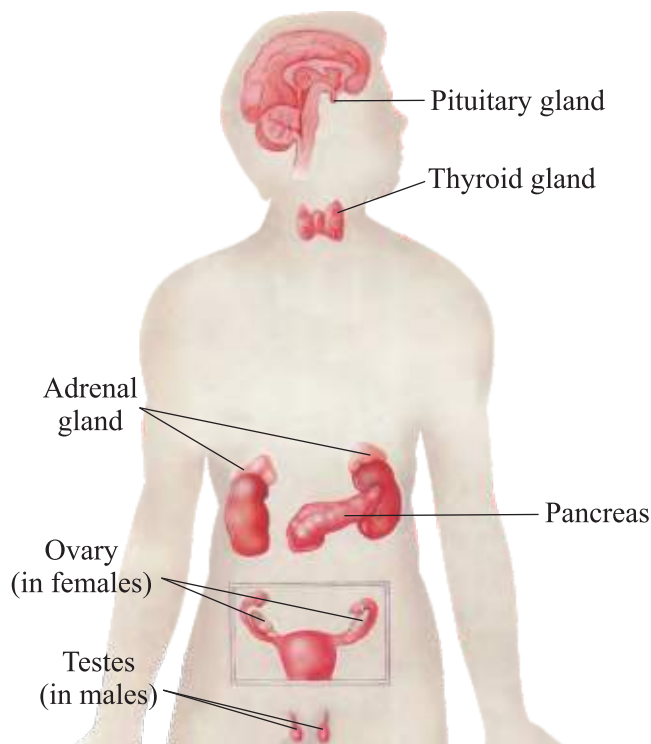

Fig. 4.2: Various endocrine glands

### Pancreas

Pancreas is a long, soft and leaf like organ present below the stomach at the junction of lower end of stomach and small intestine. It synthesizes two hormones: the insulin and glucagon. Both these hormones function antagonistically to control the sugar level while glucagon works in an opposite manner and increases the blood sugar level. Under secretion of insulin causes diabetes in human.

### Gonads

The sex organs are called as gonads. The hormones of **testes** are responsible for the development of male sex organs and secondary male sex characters. For example increase in size of larynx and change of voice in body. In addition they also play a role in the appearance of hairs on the face and body.

The hormones of **ovary** are responsible for the development of female sex organs and secondary female sex characters.

## 4.5 Different Stages of Human Life

Human beings pass through various stages in their life infancy, childhood, youth and old age.

### Infancy:

This stage spans over the first two years in the life of every human being. This is an important phase in human life. It is characterized both by physical and mental development of a child. A child gains enough weight during the first 24 months of its life. It starts teething and learns to walk and speak. It starts differentiating colours and shapes in just first three months of its

life. In the beginning they just move their hands and legs but later start curling on the belly. Normally an average baby starts walking after 13 to 15 months of its birth.

### Childhood:

Early childhood extends from two to six years. It is a period of great revolution in the thoughts and memory of a child. A child becomes capable of understanding his own feelings and his relationships with others. This period is characterized by mental, physical and behavioral development of the child.

The period after childhood extends from six to twelve years of life. In this period such qualities as power of decision, reasoning and arguments, social and self understanding reaches at its peak.

### Adolescence

This stage is a period of physical, psychological and social development of a child which covers the part of life between 13 to 19 years of age. During this phase a child enters the youth age. As this period acts a bridge between childhood and youth so the signs of adulthood start appearing in the child. This is commonly known as puberty.

### Youth and Old Age

Man after completing all the stages of childhood and adolescence gradually enters the youth age. At this stage certain negative changes start occurring in its body and the rate of catabolism exceeds the rate of anabolism. This leads to weakening of the body and it becomes difficult for the body to cope with negative external and internal changes. The phenomenon of getting old is called as **aging**. As these negative changes continue to proceed in the body gets weaker and weaker and a stage is achieved when our body systems stop functioning and finally the death occurs.

Aging greatly affects heart and its associated vessels as their elasticity decreases. The blood pressure is raised and thus the chances of hemorrhage increase. Bones become weak and fragile due to gradual loss of organic matter.

## 4.6 Exercise and Health

Whether you are doing exercise alone or in group, it is always a happy experience. Exercise maintains the elasticity of the body and due to this elasticity the muscles and joints



Fig. 4.3: The children doing exercise

never get strained. When the muscles are strong, a person can perform tough physical jobs. Strong muscles not only help to perform strenuous physical tasks but also provide support to our bones and joints.

People who do not take exercise are unable to burn their excess fat energy that accumulates in their body. Such people become obese. Exercise is the only way to save yourself from obesity as it helps to burn all the supply of energy.

Every one can take exercise, even the people suffering from heart disease and diabetes can take exercise after consulting their physician.

We are Muslims . We are naturally benefitted by our prayers both physically and spiritually. Prayer is also a light exercise during which almost all the muscles of the body move. During prayer the metabolism of muscles increases due to their increased energy needs.

## 4.7 First Aid

First aid is a help given at the place of accidents till the patients reach the hospital to save their life.

### Animal Bite

If any animal bites or scratches the body of a person, it may be dangerous. The wound may become infected. When a kitten scratches the body of a person, the bacteria enter into his body that may cause rabies or tetanus. Sometimes the scratched or bitten part of the body may also bleed. In such cases pressure bandage should administered until it stops bleeding. This is only possible if it is a minor injury. Cover the damaged area with clean cotton or piece of cloth. Patient should immediately be taken to the hospital.

### Burn

Every year thousands of people die of burning. If some part of the body burns then put off the cloths from the burnt part. Run off the tap water on burnt area. Do not administer butter, grease, oil, tooth paste, egg or any cosmetic powder on the burnt area. In case of severe injury rush to the nearest hospital.



Fig. 4.4: First aid box



Fig. 4.5: Run off the tap water on burnt area



## Eye Injury

Ordinary irritation in the eye stops by washing it in clean tap water. If sand or dust particle enters in the eye do not rub it as it may injure the upper protective covering of the eye. Eye should be washed carefully to remove the dust or sand particle. If this cannot be done by yourself take the help of some first-aider who should first of all clean his own hands. He should open the eye of the patient to have a close look in it. Take the patient to wash basin and wash the eye carefully by opening the eye lids so that the particle or hair is removed. If the dust or sand particle still persists and irritation continues, the patient should be taken to the hospital.

## Coma

The state of coma can be very seriously dangerous in the life of a patient in two ways. During coma, the tongue may stick to the palate resulting to suffocation or heart may stop functioning. So in coma, first the breathing must be ensured. If the patient is breathing, lay it straight without any pillow below the head. Lift the legs and arms towards the head and take the patient to the hospital.

If the patient is breathless lift the chest of the patient slightly upward so that the respiratory tract may become straight. Open the mouth of the patient and remove any blood, vomiting or secretion accumulated in the mouth. Clean the mouth with your fingers or handkerchief. The respiratory pathway become clear and the patient may start breathing. If the patient is still breathless, try to breath it artificially. If breathing starts take the patient to the hospital.



Fig. 4.6: Lifting of the chest cavity if the patient is breathless

## Snake Bite

If snake bites then immediately take the following steps:

1. Tie up the arm or leg tightly with some rope or cloth so that poison may not move further.
2. Wash the wound with water.
3. Lay down the patient and restrict its movement.
4. Don't try to suck the patient's blood as it may prove fatal to the first aider.
5. Let the wound bleed.
6. Take the patient to hospital as soon as possible so that some antivenome drugs should be administered.

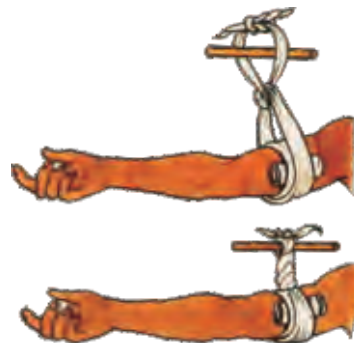

Fig. 4.7: Tie up the arm tightly in case of snake bite

## IMPORTANT POINTS

- The major components of human food are carbohydrates, lipids, proteins, vitamins and mineral salts.
- Carbohydrates are the primary source of energy for all the animals.
- Fats and oils are formed by chemical combination of fatty acids and glycerols.
- All the proteins are made up of amino acids.
- Vitamin A,D,E and K are fat soluble while B and C are water soluble.
- All the endocrine glands bring about coordination in the body.
- A man passes through various stages like infancy, childhood, adolescence, youth and old age.
- Exercise is necessary to maintain human health.
- In case of emergency first aid should be administered as it may improve the chances of survival of the patient.

## GLOSSARY

### Fat Soluble Vitamins

The vitamins that dissolve in fat e.g. vitamin A,D,E and K.

### Endocrine Glands.

The glands whose secretions are transported through blood.

### Hormones

These are the chemical messengers secreted by the endocrine glands and transported through the blood to their site of action.

## QUESTIONS

Q1. Fill in the blanks

- (i) The most abundant naturally occurring carbohydrate of the world is \_\_\_\_\_ .
- (ii) Fats and oils are formed by chemical combination of fatty acids with \_\_\_\_\_ .
- (iii) Deficiency of vitamin \_\_\_\_\_ causes night blindness.
- (iv) Goiter is caused by the deficiency of \_\_\_\_\_ .
- (v) Insulin and \_\_\_\_\_ are formed in pancreas.
- (vi) Rabies is caused by \_\_\_\_\_ bite.

Q. 2 Place (✓) in front of correct statement and (✗) in front of wrong statement.

- (i) Glucose is the building block of proteins.
- (ii) Vitamin A is a fat soluble vitamin
- (iii) Rickets is caused by vitamin C deficiency.
- (iv) One gram of fat gives 4.1 kcal of energy.
- (v) Thyroxin hormone is secreted by parathyroid gland.

- Q3.** Encircle the correct answer from multiple choices
- (i) The compound which is required in very small amount is  
(a) Carbohydrate (b) Proteins (c) Fats (d) Vitamins
  - (ii) The amount of energy gained from one gram of fats is  
(a) 9.3 Kcal (b) 18 Kcal (c) 27 Kcal (d) 36 Kcal
  - (iii) The disease which is caused in children due to vitamin D deficiency is  
(a) Scurvy (b) T.B. (c) Rickets (d) Anaemia
  - (iv) The hormone which controls involuntary action of body is  
(a) Thyroxin (b) Epinephrine (c) Adrenal (d) Insulin
  - (v) The disease caused by deficiency of iodine is  
(a) Goiter (b) Night blindness (c) Malaria (d) Cough
- Q4.** Short Questions:
- (i) What are the basic components of food?
  - (ii) What is the role of vitamin B in body?
  - (iii) What is the role of iron in the body?
  - (iv) Which disease is caused by dog bite?
  - (v) What is the role of insulin?
- Q5.** Write a note on important components of food.
- Q6.** What do you know about protein?
- Q7.** What are vitamins? Describe them in detail.
- Q8.** What is balanced diet? Describe the balanced diet for various people of our society.
- Q9.** Why exercise is important for health?
- Q10.** Discuss the role of various endocrine glands in our body.

# 5

## DISEASES - CAUSE AND PREVENTION

In this chapter you will learn:

- Diseases caused by viruses, bacteria, parasites and fungi, their spread and their preventive measures.
- Spread of microorganisms through air, contact, faeces, animals and skin abrasions and wounds.
- Preventive measures against microbial diseases.
- Diseases caused by smoke and smoking.
- Mental diseases and their treatment .
- Differentiation between drugs, medicines and addiction, their uses, abuses and effects on society.

Microorganisms are the living cells which are present all the time around us in the environment such as earth, air, water. All the infectious diseases are caused by microscopic bacteria and viruses. These organisms are of different shapes and sizes. Nevertheless some disease producing organisms can be seen by human eye, such as intestinal worms etc. The fungus look like plants but they have no roots, stems and leaves and these can also cause many diseases.

### 5.1 Diseases Caused by Germs

Virus, bacteria, fungus and worms can cause many diseases.

#### Viral Diseases

##### Small pox

It is an acute infectious disease. Now this virus is non-existent in the world as an

#### Dengue Fever

It is caused by Dengue Virus. Dengue Fever is also known as Break Bone Fever due to severe joint pain. Detail is given on page 176

infectious agent but it is kept in the laboratory for further experiments in South Africa, Russia, Great Britain and America (USA). The common symptoms of this disease are acute fever, headache, backache, vomiting and fits which occur often in children. On third or fourth days of fever spots may occur on arms and legs.

This virus may affect both sexes at all ages. One attack of smallpox may produce immunity for whole life and second attack is very rare. The virus spreads by the coughing, sneezing, talking to the patient and thus enters the respiratory tract of the healthy people.

### Poliomyelitis

Polio is an infectious viral disease. Poliomyelitis is very common in the children below 2 years of age. It is primarily an infection of the human alimentary tract, the virus gains entry by the

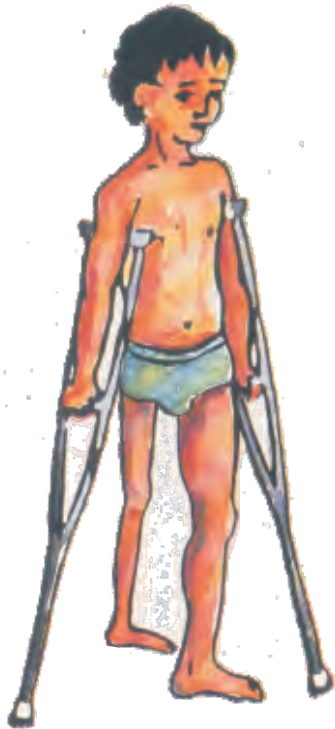

Fig. 5.1: The effects of polio



Fig. 5.2: Preventive measure against polio

## Polio Day

Give your children the drops of polio till 5 years of age to save them from this disease.

eatables and water. It may affect the central nervous system resulting in varying degrees of paralysis. The patient feel cold and fever, vomiting and pain of muscles. Often paralysis does not occur but if the infection is severe then paralysis of any part may occur. Poliomyelitis may paralyse one or both legs which causes weakness and retards the growth of the limb. Once paralysis

Protect your child by giving polio vaccine at birth then at 6th week, 10th week, 14th week and finally at 9th month.

of poliomyelitis occurs then no medicine can cure it. Antibiotic are also of no help. The child who is paralyzed by poliomyelitis, should be given balanced diet to promote defence system of his body. He should do regular exercise and physiotherapy to strengthen the other muscles of the body. During the first year of the disease some improvement is expected.

The sick child should be isolated, from other children in a separate room. Polio vaccine is the main protective method available. The expanded programme on immunization in Pakistan is a milestone in polio vaccination.

### Influenza or Flue

Influenza virus is of three types, type A, type B and type C influenza virus, but type A and type B are more dangerous.

Influenza is a rapidly spreading disease which spreads from one or two patients and finally involves the whole world.

The main symptoms of influenza are sore throat, fever, cough, watery nose, watery eyes, headache, and muscular cramps. After a minor work the patient gets tired.

The influenza virus attacks all ages and both sexes equally. It is more prevalent in winter and during the raining season. It spreads more rapidly in places where people are over crowded. The virus spreads by droplets released by coughing, sneezing and even talking to the patient in the air and inhalation of the same viruses in the droplets by the healthy people.

The hand kerchief, towels and other articles in patients use also play an important role in the spread of influenza. Influenza is a notifiable disease to the health department. This disease is prevented by vaccination.

### Measles

Measles is a highly contagious disease which has high mortality rate in children. The main symptoms of measles are fever, chills, running nose, congested red eyes and cough. It spreads by virus contained in the very minute skin lesions. The disease becomes slowly severe. The sick child may feel pain in his mouth, develop diarrhoea (loose motion), pneumonia, malnutrition and infection of ears and eyes may occur. Two or three days of the disease the Koplik's spots (tiny white lesions of mucous membrane of the mouth) may develop. At the same time red lesions develop on the skin, first on the back of ears, on the neck and then face and lastly on the arms and legs. The child starts improving after the skin eruption is complete. The skin lesions remain for about five days. The affected children should be isolated

At the age of 9 months, the child should get measles vaccination done. The children must be given good nutritional diet to save them from dying of measles.

from healthy children, especially those who are malnourished, patients of tuberculosis or suffering from other chronic diseases. The patient should rest in bed. More and more liquid and balanced diet should be given to the patient. If an infant is unable to suck mother milk then mother should milk herself and feed the infant by spoon.

### AIDS (Acquired Immune Deficiency Syndrome)

AIDS spreads by a virus which destroys the immune system of the human body. Any disease which attacks such a patient may prove fatal and end up in death. The AIDS virus is called H.I.V (Human Immune Deficiency virus.)

AIDS is not an infectious disease. It does not spread by touch, sitting with the patient, shaking hands or working together. HIV positive people do not show any illness or weakness. The symptoms of AIDS often take many years to develop. When the symptoms appear, and the patient is diagnosed for the case of AIDS, then the patient may live for about 2 years.

The AIDS virus is present in the blood and in the secretions of the sex organs of the patient. The virus is also present in saliva (secretion of mouth), tears (secretion of eyes) urine and in the sweat of the patient. The HIV virus spreads by the transfusion of blood or blood products, donated by an AIDS patient to a healthy recipient.

The practice of using common syringes may also help the spread of the disease. The HIV may spread from pregnant mother to the new born baby and also from affected sexual partner to other sexual partner. The disease can also spread through the barber's blades.

The early symptom is as simple as minor flu and then the man is free for any symptoms for months and years. Slowly he develops the apparent AIDS symptoms. There is a rapid loss of weight of the affected person, and loose motion may persist for a month or so. Fever, cough and pneumonia may develop. Some depigmented areas may develop on the skin.

The preventive measures of AIDS are to obey the laws of Quran. Always use disposable syringes. HIV screening of blood must be done before donating the blood.

### Hepatitis

Hepatitis is the inflammation of the liver. The hepatitis virus is of many different types and similarly are the types of hepatitis. The main types of hepatitis are:



Fig. 5.3: The effects of measles



**Hepatitis A:** Hepatitis A is caused by HAV (Hepatitis A Virus). The main symptoms of Hepatitis A are anorexia (loss of hunger), nausea, and inflammation of the liver and later on jaundice. The hepatitis A virus is discharged in the faeces of the patient and spreads to others by water, food and milk. Usually one attack may develop life long immunity.

There is no vaccine against hepatitis A. The main protective measures include prevention of adulteration of food and milk. Also HAV screening of blood should be done before donating the blood.

**Hepatitis B:** Hepatitis B, which is caused by a dangerous HBV is a dreadful disease with a high mortality rate.

Hepatitis B-virus spreads by infected blood, tears, sweat, and other body fluids of an infected person to other healthy individuals. The severity of the problem can be judged by the fact that in Pakistan one person out of every ten people is a carrier of Hepatitis B virus. Carrier is a person who is apparently looking healthy and is harbouring the disease organisms in his body, but he spreads the disease in the community. The only prevention against this disease is vaccination. Two injections of Hepatitis B vaccine are given with one month interval each, and a booster injection is given at six months interval of the first dose. The hepatitis B patient should take rest and use excess amount of water and juices. Sugar cane juice is very useful. More and more juices should be given if the patient is unable to eat food, but if he can eat food then balanced diet should be given to him. Beans, meat, poultry and boiled eggs are best for this purpose.

**Hepatitis C:** This disease produces inflammation of the liver. It is caused by hepatitis C virus. It is more prevalent from 20-39 years age group.

Hepatitis C virus predominantly spreads through transfusion of infected blood, repeated use of syringes and needles and accidental needle prick in the laboratory workers. Loss of appetite, vomiting, fatigue, weakness, joint pain and fever are the main symptoms of this disease.

Hepatitis C patient should be isolated. No vaccine is available against this disease. Immediately destroy the blood and other body fluids of the patient, such as sputum and urine. Wash hands thoroughly with soap after attending the patient.

## **Bacterial Diseases**

These are the diseases caused by bacteria.

### **Tuberculosis (TB)**

It is a chronic disease of long duration and can attack any person especially weak and malnourished people and living with a patient of tuberculosis.



Tuberculosis is a treatable disease, even then hundreds and thousands people die due to it. Tuberculosis should be diagnosed and treated in early stages. This disease involves mainly the lungs but it can affect any organ of the body. The patient should be given well balanced diet as a routine.



Fig.5.4: The effects of TB

All the people living with a T.B patient should be screened for tuberculosis. The children should be vaccinated against tuberculosis. The patient should be isolated from healthy children. The T B patient should cover his mouth during coughing and should not spit on the floor because when a T B patient cough, sneeze or spit very minute droplets of saliva are discharged in the atmosphere which contain millions of germs of tuberculosis. These mycobacteria get entry through the air into the lungs of healthy people during respiration and cause tuberculosis.

T B is a dangerous and rapidly spreading infectious disease. It can be prevented by B C G vaccination given at birth.

The main symptoms include over one month continuous cough, bloody sputum, continuous fever, night sweating , loss of appetite, loss of weight and feeling of tiredness after a little work.

### Whooping cough

Whooping cough is an infectious disease. Its incidence increases in winter and spring seasons. Whooping cough may persist for three months. Whooping cough spreads by minute droplets of bacteria released by coughing, sneezing and talking from the mouth of the patient and enters the respiratory system of other healthy children by inhalation and causes disease in them. The disease starts after two weeks of entering the bacteria in the body. The episode of

cough persists for long time without respiration and this stage ends up in a group. During the episode of cough, oxygen in blood decreases which produces blueness of the finger nails and lips of the child. This episode of cough may end in vomiting. Child may look healthy during the attacks. The whooping cough may prove fatal for children under the age of one year. D P T vaccination should be done at a proper time.

Whooping cough is basically a disease of the young children. Its incidence is higher below 5 years of age and it is more fatal in female children than the male children. Its other symptoms are mild fever, throat irritation, severe cough accompanied by loud crowing voice. If it is not treated in time, it leads to pneumonia.



Fig. 5.5: Spreading of whooping cough

### Diphtheria

Its prevalence is world wide. The developed countries of the world has practically controlled it by vaccinating their children against this disease. The disease starts with flue, fever, headache and sore throat. The bacteria attack the mucus membrane of the throat and nose and produces inflammation of the membrane and changes its colour to dark brown. It may cause swelling of the neck. The breath of the child become foul smelling.

The diphtheria germs may affect the cardiac muscles, cause their weakness which may result in death of the patient. Diphtheria is an air borne disease affecting other healthy people.

The patient should use plenty of liquid diet. He should be isolated from other healthy children and first aid be provided immediately. He must gargle with light warm salt water. Steam inhalation is also recommended. The child should be shifted immediately to hospital if suffocation occurs.

Diphtheria is a fatal disease. It can be prevented through D P T vaccination.

### Tetanus

Tetanus is an acute disease. Their germs remain alive in the dust, faeces of the man and animals. If a person is injured in a roadside accident, these germs enter the wound and produce toxins. There is also danger of tetanus if an animal like cat, dog, etc. bites a person.

All the body muscles become stiff and remain stiff during the whole course of disease and then severe jerking movements occur in the muscles. This causes severe pain to the patient. The stiffness of the mouth muscles cause closing of the mouth, which is called **lock-jaw**. There is a difficulty in swallowing food. Later on muscles of the neck become stiff. There are severe fits and if the patient is touched the muscles again go into spasm as in fits. Tetanus injection should be given if a person gets injury.



Fig. 5.6: The effects of tetanus

The D.P.T vaccination save the child from tetanus.

### Typhoid

Typhoid is endemic in all the countries of the world. In the developed countries of the world by better civic conditions and better quality of food, water and milk, incidence of this disease is reduced to a great extent. These germs remain alive in the human body. The patient or the carriers of typhoid excrete the bacteria in their faeces. When these bacteria mix with food, water, milk, etc., is transmitted through a man or fly then any person consuming these items may also ingest these germs which causes typhoid fever in that person. This disease is manifested by headache and fever of long duration. Usually typhoid fever is common in 10-30 years of age group and more in the rainy season and flies are important for its spread. Typhoid fever may occur by drinking the polluted water or by taking contaminated food.

Some preventive measures of typhoid are to drink boiled cool water, thorough washing of fruits and vegetables in plenty of clean water, cover milk and milk products. Do not eat stale food, avoid from ice creams and ice balls. Screen the houses and shops from the flies. Protect all age groups by vaccination as one injection may protect for 3 years.

### Interesting Information

The germs of typhoid multiply and grow rapidly in milk without changing its taste and colour.

### Cholera

This disease is characterized by watery stools. The severity of this disease may range from minor ailment to very severe condition in which watery stools abruptly start. It may accompany vomiting, which may produce dehydration in the body. The urine is scanty. The muscles start aching due to loss of salts from the body. About 30% to 40% patient of cholera die if not treated in time. Polluted water, food and milk are the main sources of spread of disease. The

direct contact of the patient with healthy person is also one of the reason of the spread of this diseases.

Always drink clean water, eat clean fresh food, do not eat stale fruits. Wash your hands with soap before eating. Protect milk and milk products from flies and cover the food articles.

## Fungal Infection

Fungal infection can attack any part of body skin.



Fig. 5.7: The effects of fungus on skin

## Ring worm

Ring worm usually appears in round circles on the skins, accompanied by itching. Ring worm of head may cause falling of hair in patches. The nail fungus may damage the nails. Ring worm is a contagious disease. Affected person should not have direct contact with healthy person. In preventive measures do not use others combs and towels. The patient should be treated promptly. The affected areas should be washed with water and soap daily. The lesion should be kept dry. The socks should be washed properly.

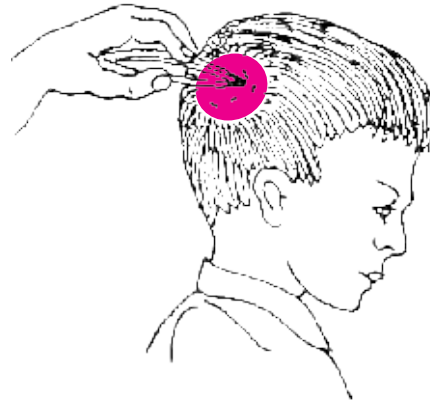

Fig. 5.8: The ring worm appears in circle

## Parasitic Diseases

### Malaria

Malaria fever is transmitted by the bite of female *Anopheles* mosquito. The first symptom of malaria is feeling of chill and then the temperature rises upto 104°F. The size of spleen can increase if there is chronic fever. In the third stage the patient perspire and temperature decreases. In Pakistan malaria occurs between July to November. The most important step in

controlling malaria is to kill the mosquito. It is done by spraying insecticides in the houses and filling of ponds and other breeding places. Crude oil is sprayed on the surface of water which kills the mosquitoes and their larvae. During night mosquito repellent oil should be used on the exposed parts of the body, use mosquito nets during night and lastly use chloroquinine for the protection against malaria.

The doors, windows, ventilators should be screened by net to prevent the entrance of the mosquitoes. The ponds around the houses should be filled with soil to cut down their breeding places while on other ponds, used mobile oil is spread so that the mosquitoes do not lay their eggs. Insecticides should be sprayed in the houses. During spray all the household things should be taken out and for the next 2 months the rooms should not be white washed.



Have a blood test for malarial fever



Complete the course of medicines.



Cover the windows and doors with nets.



Fill the holes with clay near your house.



Have a spray in your house to prevent from malaria.

Fig. 5.9: The preventive measures against malaria

### Round worm

Round worm is the common name of *Ascaris lumbricoides*. The worm is about 20 centimetre to 30 centimetre long and is pink in colour. The worm is clinically manifested by symptoms of nausea, vomiting, gastritis and cough. The live worms may pass through the faeces or may be vomited out.

These worms live in human intestine and move freely there. Their eggs are discharged through faeces in the soil and become infective in 2-3 weeks. On ingestion by man these embryonated eggs



hatch in the small intestine. These eggs hatch and larvae are released in the small intestinal wall and are carried to the liver and lungs via the blood stream. The larvae are coughed up through the wind pipe and then swallowed by the man into the stomach and then into small intestine. On reaching the intestine, they become mature. The life span of an adult is between 6-12 months.

The infection rates are high in children than the adult, and children are the most important source of spread of the worms. They contribute to malnutrition especially in children who may show growth retardation. The onward transmission of the worms may be accomplished by strictly implementing the primary hygienic principles.

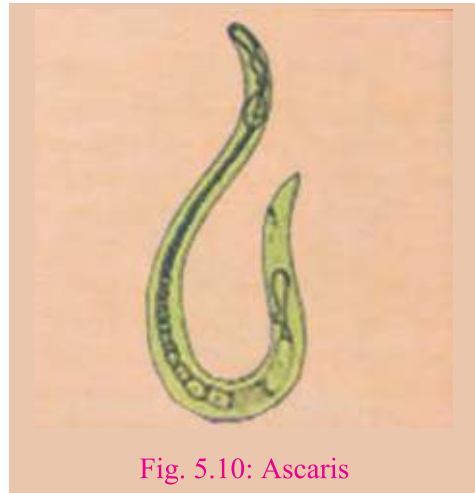

Fig. 5.10: Ascaris

Water should be boiled before use. The salad, vegetables and fruits should be thoroughly washed before eating. Hand should be washed before and after eating and before cooking of food. The food should be covered from the flies and dust.

### Thread worms

The thread worms are small, thread like measuring one centimetre in length. They are white in colour. These lay eggs around the anus in thousands. They cause an irritation especially during night. Due to unhygienic conditions these eggs pass in the faeces of one person and are ingested by another. The eggs may also be spread through affected persons nails. This cause the onward transmission of the threadworm in other children by the ingestion of eggs. The eggs mature in the intestine and hatch in larvae which transform into adults in the intestine.

The thread worms are not dangerous but due to anal irritation these disturb the child during sleep. The anal area of the child should be washed thoroughly early in the morning and after each defecation. Hand and nails be washed properly with soap. The clothes of the child should be changed and washed properly and dried up in the sun. The important preventive step against thread worms is personal hygiene of the child.

## 5.2 Agents Spreading the Germs

The germs spread by different ways as air, water, and animals etc.

### Air

Those diseases which spread by inhalation of microorganisms in the air through

respiratory track are called “Air Borne” diseases. When a patient of such diseases talks, coughs, laughs or sneezes then thousands of droplets of the secretions of mouth and nose are expelled in the air and remain suspended for some time. The microorganisms also remain suspended along with these droplets and gain entry through the mucous membrane of the respiratory tract during respiration in other healthy people around. Some air borne diseases are flu, measles, whooping cough, and tuberculosis. These diseases spread more rapidly if the patient coughs and spits openly in over crowding and poor ventilation.

### Touch

The germs spread from a patient to other healthy people by either direct or indirect contact. The disease producing germs may affect other healthy person by direct touch of his skin as in scabies. In the indirect method the germs spreads by touching the different items of his use such as clothes, bedding and utensils etc.

### Faeces

The organisms passed out through faeces and spread disease via soil, food, water and hands. The faeco oral diseases are diarrhoea, polio, hepatitis, typhoid and worms.

### Animals

The disease producing germs may spread in the humans by animal bites through saliva as rabies spread by the bite of dog which transmits the rabies virus into the human blood. The malaria is also transmitted through the mosquito bite.



Fig. 5.11: Animal bite

### Scratches and Cuts

The germs get entry into the human body through wounds and scratches. For example in a new born when the umbilical cord is cut with an infected knife or blade, through burn skins, wounds of animal bite, and infected nail may spread the disease producing germs through the wounds.



Fig. 5.12: Scratch by thorn

### Water

Water is a great gift of God. Water is a basic constituent of health and human body. Every drop of water is a life for man.

The untreated water discharged by factories, domestic used water mixed with phenyl and

acid, insecticides used in crops, and use of fertilizers may pollute the water. This causes many diseases in human body e.g. typhoid, cholera, heart diseases, liver, intestinal diseases and kidney problems.

### 5.3 Protection from Germs

The disease producing germs are present all around us. These are found in air, food, water, faeces, on the skin, clothes, animals and in soil. The germs can be prevented from spread by the following ways.

#### **Sterilization**

This is the best method of killing the germs. During the process of sterilization, milk, fruit juices and other food items are heated for 1-2 seconds at 148.9 degree centigrade. This process kills not only germs but also their resistant spores. Once sterilized, the food items can be kept at room temperature for many days.

#### **Control on disease transmitting animals**

The mosquito and squids spread the disease producing germs to man. By killing mosquito and squids we can control malaria and bilharzia. The mosquito can be killed by spraying insecticide such as D.D.T. Similarly by killing the rabid dogs we can control the rabies in man.

#### **Vaccination of pet animals**

The pet animals such as dogs, cats, parrots, can be made safe from producing diseases in man by proper vaccination. The proper look after and treatment of animals can reduce the risk of rabies and skin problems.

#### **Isolating the infectious people**

The diseases can be prevented by isolating the infectious people which are able to spread the disease in other healthy people. The children suffering from measles and scabies should not be allowed to go to school. Keep them at home. Treat them properly. These measures can prevent the spread of infectious diseases.

#### **Personal hygiene**

Personal hygiene such as daily bathing is very much essential to remain healthy. Wash your hand, with soap before and after taking foods (meal). Brush your teeth daily. Trim and clean the nails to prevent germs stay and grow in them. The clothes should be washed with soap and dried in the sun. The hair should be cared properly. The lice and their eggs should be treated properly.



## Importance of Pure Water

Water is a great blessing of God. It is necessary for the life and health of human beings. Two thirds of the earth consist of water, but even then half of the world population is deprived of drinking water.

## Sewage Disposal and Sanitation

Proper sewage disposal is necessary to control the water borne diseases and malaria. The mosquito lays eggs in stagnant water, so malaria can be controlled by proper sanitation and sewage disposal.

## Immunization

Six fatal diseases can be prevented in children if fully vaccinated at one year of age. The six disease are tuberculosis (TB) whooping cough, measles, diphtheria, polio and tetanus.

The females during reproduction can also be saved from tetanus by vaccination against tetanus. It is noteworthy that to make the immunization successful, 80% of the children in the community should be vaccinated.

## Antibiotic Drugs

The drugs that are used to treat the disease produced by the bacteria are called antibiotics. The viral diseases such as flue, measles, etc are not controlled by the antibiotics, so antibiotics should not be prescribed in viral diseases. Penicillines and tetracyclines are examples of antibiotics.

## 5.4 Effects of Smoke and Smoking

Some people chew the tobacco while other use it in cigarettes. Tobacco smoke consists of many chemical substances. Nicotine, tar and carbon monoxide are the most important chemical substances. Nicotine is a very poisonous chemical compound which causes addiction and which makes difficult to quit smoking in the smokers. Another most important effect of nicotine on the human body is that it causes the narrowing of the blood vessels which hinders the blood supply to all the organs of the body.

Tar is a gelatinous material which collects around the lung tissues and the function of the lung is affected. Tar also causes lung cancer.

Carbon monoxide present in the cigarette smoke combines with the haemoglobin of the blood and reduces the oxygen content of the blood. Because all the tissues of the body require oxygen for their proper function, just to compensate the low oxygen supply, the heart has to

work more, which causes more burden on the cardiac muscles. These are some of the reasons, that smokers have more incidence of heart diseases than the non-smokers.

Man is making progress in industries. The population of the world is also increasing at a rapid pace. Along with the human activities, the amount of smoke is also increasing in the atmosphere, by industrial and domestic activities. The smoke consists of carbon monoxide, chloroflourocarbon, (CFC's) oxides of nitrogen and sulphur.

This smoke collects below the ozone layer and by increasing its thickness. It causes rise in temperature of atmosphere of earth and that changes the climate. Sometime these gases in smoke start eating ozone and produce holes in ozone layer. These holes in ozone layer cause genetic mutations in the man, plants and animals. It also increases the incidence of skin cancers in the humans.

### **Respiratory Diseases due to Smoking**

Cigarette smoke causes the inflammation of the bronchi, bronchioles and the lungs which is the main reason of cough and sputum. The inflammation of the wind pipe (trachea) and bronchi is called bronchitis. The smoking damages the air sacs in the lungs. This reduces the oxygen exchange in the blood. The patient has to breathe faster to compensate this if causing damage to him. This disease is called emphysema.

### **Heart Diseases due to Smoking**

Smoking predisposes to heart attacks, hypertension and other heart ailments which are the main cause of death in smokers. The blood vessels including arteries and arterioles become narrow and especially the coronary arteries of the heart are more affected. This increases the heart attack chances more.

### **Skin Diseases Caused by Smoking**

Most common skin disease is skin allergy. The skin colour also changes because of low oxygen content in the blood. The skin wrinkles and aging symptoms begin to appear.

It is our duty to make free our society from smoking.

## **5.5 Mental Diseases**

Psychosis and neurosis are the important mental diseases. The detailed description of these ailments is as under.

### **Psychosis**

Delerium and depression are common diseases of psychosis.

### **Delerium**

This disease appears acutely and is caused by addiction of certain diseases, electrolyte imbalance in the body and oxygen deficiency. The main signs and symptoms of the disease are incoherent speech, fits, rapid movements of the eyes, double vision. In somnia, anxiety, stupor, sightedness, and fear from people. There should be counselling to patients that they should trust on other people.

### **Depression**

In this disease a person is always in tension and in low spirit. Mostly the person is depressed in early morning. The patient's thinking and decision making power is reduced. He is under the influence of inferiority complex and self blaming. The patient complains the loss of sleep (insomnia), loss of appetite and thus he loses his weight. He also suffer from headache and back pain. It is recommended that all his business and domestic responsibilities be cancelled and through counselling his life pattern should be made better.

### **Neurosis**

In neurosis hysteria and phobia are noteworthy.

### **Hysteria**

The females are more prone to this disease. During the hysterical fit a patient may experience blindness, deafness, headache, ringing in the ears, stammering, paralysis, and fits etc. The patient may refuse to eat due to loss of appetite. The patient should be counselled for longer periods and encouraged to talk more about his problems. Try to solve his/her problems otherwise the same attack may recur.

### **Phobia**

In this disease the patient feels undue fear from any place or person or things like bus, open space etc. The patient starts avoiding from that place or thing. Consult the doctor for his treatment.

### **Nervous Breakdown**

The patient of nervous breakdown, is under the influence of depression, which does not persist longer and this affects the life pattern of the patient. Depression and nervous breakdown occurs when the person enters a new pattern of life accidentally, loneliness, after long illness, financial problems, death in family and separation or divorce. Some females get depressed after delivering the baby. According to recent researches a chemical neurotransmitter may cause depression when its production is low. The patient remains unhappy and starts avoiding from the things around him. He shows no interest in those things in which he was very much interested in

past. He becomes negative particularly about his future. His decision making power also decreases and he starts forgetting the things. If these symptoms persist then he can try for suicide.

## 5.6 Drugs and their Effects

Drug is usually any type of medicine which is used to treat the disease. These are used to relieve pain to prevent diseases and to save the life. Some drugs are used for protection from diseases, and are called vaccines. The vaccines produce antibodies in the body and these antibodies protect our bodies from many diseases. As for example if a child is given injection of measles vaccine, he is protected from measles because vaccine produces antibodies against measles virus.

Many people think it as unlawful drugs which produce sleep. In fact there are the drugs which are harmful and dangerous for the users and it is also unlawful to keep them and to trade. Almost all types either lawful or unlawful drugs are dangerous to some extent, but people have to use drugs to treat the disease and to relieve the pain.

### Medicines

The drugs which are used according to the prescription of doctor and in suitable amount for treatment of disease are called **medicines**.

### Pain killers

These are those medicines which remove headache. Examples are aspirin and paracetamol.

### Narcotics

Those drugs which relieve pain, promote sleep, produce addiction are called **narcotics** e.g. opium, morphine. The unlawful drugs which cause addiction, their danger lies in the fact that these drugs produce addiction in the user and then he is unable to leave the drugs. His will power ends and at last he reaches that point where he neglects his official duties, family life, self respect, honour and dignity and he indulges in theft and even murder to get addiction. The addiction of drugs are of the following categories.

### Sedatives

Those drugs which cause sedation are called sedatives e.g. diazepam, lorazepam etc.

### Hallucinogens

Those substances which disrupts the brain function to the extent that the person is unable to recognize time, place, sound, colour and vision are called hallucinogens e.g. cannabis.

## IMPORTANT POINTS

- Small Pox, polio, flue, measles, AIDS and hepatitis are viral diseases.
- Tuberculosis, whooping cough, diphtheria, tetanus, typhoid and cholera are bacterial diseases.
- Mosquito, *Ascaris* and thread worm can cause many diseases.
- Germs spread by air, water, touch, faeces and through animals.
- Diseases can be prevented by adopting different preventive measures.
- Cigarette smoke contains many dangerous gases which can cause diseases of lungs and heart in man.
- Mental diseases must be treated.
- The addiction of drugs can cause many dangerous effects on man.

## GLOSSARY

<b>AIDS:</b>	An abbreviation of Acquired Immune Deficiency Syndrome. This is a viral disease. The virus damages the immune system of body against diseases in man.
<b>Ring Worm:</b>	A fungal skin disease which spreads by circular patches.
<b>H I V</b>	An abbreviation of Human Immuno Deficiency virus which causes AIDS in humans.

## QUESTIONS

- Q1. Fill in the blanks:**
- (i) Bacteria can be seen by a \_\_\_\_\_
  - (ii) E.P.I. stands for \_\_\_\_\_
  - (iii) The AIDS virus is called \_\_\_\_\_
  - (iv) The measles vaccination is given to a child at \_\_\_\_\_
  - (v) Hepatitis virus spread by faeco \_\_\_\_\_ route through food and water.
  - (vi) B.C.G injection protects from \_\_\_\_\_
- Q2. Put (✓) against right statements and (✗) against wrong statements.**
- (i) Polio virus affects the nervous system.
  - (ii) Antibiotic drugs are used against the viral diseases.
  - (iii) Tuberculosis is a non treatable disease.

- (iv) AIDS is not an infectious disease.
- (v) Cigarette smoker remains protected from lung and heart diseases.

**Q3. Select and encircle the right answer**

- (i) The age of child in which the child is injected with measles is
  - (a) At birth
  - (b) First month
  - (c) 3rd month
  - (d) 9th month
- (ii) The drinks which can be used more in hepatitis are
  - (a) Water
  - (b) Sugarcane juice
  - (c) Juices
  - (d) All
- (iii) The age of the child in which he is given first injection of BCG is
  - (a) First month
  - (b) At Birth
  - (c) Third month
  - (d) Ninth month
- (iv) BCG saves the child from
  - (a) Measles
  - (b) Whooping cough
  - (c) T.B.
  - (d) Hepatitis
- (v) DPT is not effective in
  - (a) Diphtheria
  - (b) Polio
  - (c) Whooping cough
  - (d) Tetanus
- (vi) The chemical present in smoke of cigarette which makes the person addict is
  - (a) Tar
  - (b) Nicotine
  - (c) Carbon monoxide
  - (d) Nitrogen dioxide

**Q4. Short Questions**

- (i) In which age child is injected against measles and why?
- (ii) What is the name of AIDS virus?
- (iii) In which diseases DPT injection gives immunity to the body?
- (iv) How does the malaria spread?
- (v) Write the name of different agents causing diseases?
- (vii) What is sterilization?

**Q5.** How does the AIDS spread? Write its preventive measures?

**Q6.** Write different methods to prevent from malaria?

**Q7.** What are the effects of smoke and smoking?

**Q8.** Briefly describe some of the mental diseases.

**Q9.** What do you know about Dengue Fever?

**Q10.** Describe treatment and prevention of Dengue Fever.

**Q11.** What is Dengue Hemorrhagic Fever (DHF)? Write in detail.

# 6

## ENVIRONMENT AND NATURAL RESOURCES

In this chapter, you will learn about

- Earth's atmosphere, its composition and layers
- Depletion of ozone layer and its effects on earth.
- Absorption and reflection of energy on earth and green house effect.
- Climatic changes due to human activities.
- Types of pollution and their impact on human life.
- Use and conservation of minerals and fossil fuels.
- Crops of Pakistan, mechanized farming and modern trends in agriculture.
- Development of dairy and poultry farming.
- Wildlife, national parks and conservation of wildlife.
- Effects of over population on environment, poverty and quality of life.

### 6.1 Earth's Atmosphere

Atmosphere is an envelope of gases that covers the earth from all sides. It is about 200 km thick. The air we breathe in is part of the atmosphere. Photosynthesis and burning also occur in presence of air. Atmosphere maintains the temperature of the earth and protects from the harmful radiation coming from the sun.



Fig. 6.1: Atmosphere



## Composition of Atmosphere

The atmosphere is made up of about 78 percent nitrogen and 21 percent oxygen. The remaining one percent consists of water vapour and trace gases (carbon dioxide, hydrogen, argon, helium, ozone, etc).

Our earth is the only planet of the solar system where free state oxygen and water vapour are present. Living organisms use oxygen in respiration. Although the proportion of carbon dioxide in air is only 0.04% but this gas is also very important for life on earth. Plants utilize carbon dioxide for preparation of food during photosynthesis. All other organisms, which cannot prepare their own food, also depend on this food. Carbon dioxide also helps in maintaining the earth's temperature. Carbon dioxide is produced during respiration and burning. The proportion of carbon dioxide is increasing in the air as a result of human activities. This may raise earth's temperature and lead to climatic change.

## Different Layers of Atmosphere

Atmosphere is divided into four parts or layers. Each layer has its own characteristic features. The four layers and their important characteristics are given below:

### 1. The Troposphere

The troposphere extends to a height of about 18 km above earth's surface. Most of the gas molecules and water vapour are in the troposphere. This is the layer where most of the weather occurs.

### 2. The Stratosphere

This layer is above the troposphere. It reaches the height of 50 km from sea level. Most jet airplanes travel in lower stratosphere.

The upper stratosphere contains a layer of a gas called ozone. The ozone layer is very important to living things because it filters out most of the ultra violet (UV) radiations given off by the sun.

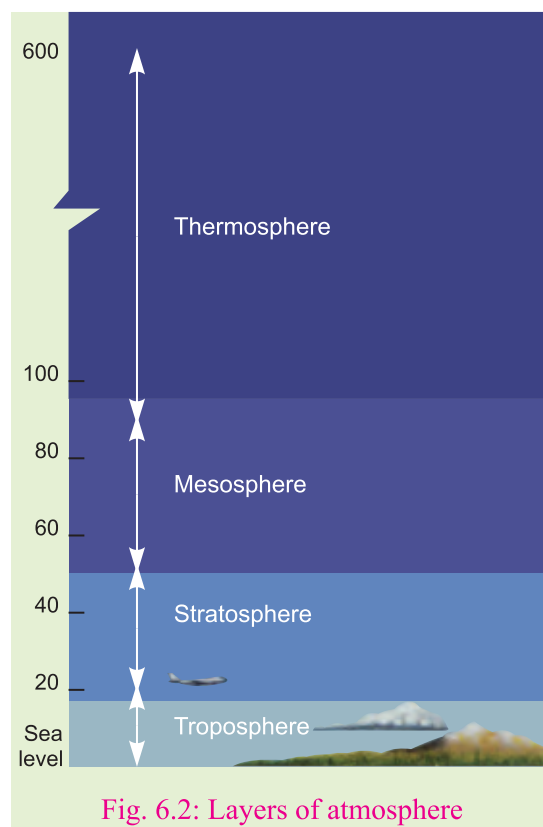

### The Mesosphere

Beyond the stratosphere is the mesosphere, which extends about 85 km above earth's surface. This is the coldest layer of the atmosphere. The temperature in the mesosphere can be as low as  $-100^{\circ}\text{C}$ .

### 4. The Thermosphere

The thermosphere is the outermost layer of the atmosphere. It is the hottest layer, where temperature may be as high as  $2000^{\circ}\text{C}$ .

### Depletion of Ozone Layer

Ozone is a gas present in the upper stratosphere. It forms a protective covering around the earth, which prevents UV-radiations from reaching the earth.

Certain chemicals are released from refrigerator, air conditioners, spray cans and factories manufacturing packing foams. These chemicals are called chlorofluorocarbons (CFCs). CFCs react

with ozone causing its depletion and thinning of ozone layer. Consequently greater number of UV-radiations reach the earth. These radiations may cause cancer and eye diseases.

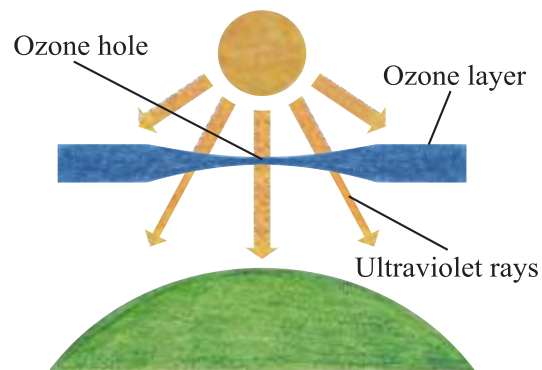

Fig. 6.3: Ozone layer

### The Energy Radiations and their Absorption in the Atmosphere

Sun is the biggest source of energy (light, heat). Radiations from the sun in the form of light come uninterrupted to the earth. These radiations have short wave length. On striking the earth they are absorbed and raise its temperature.

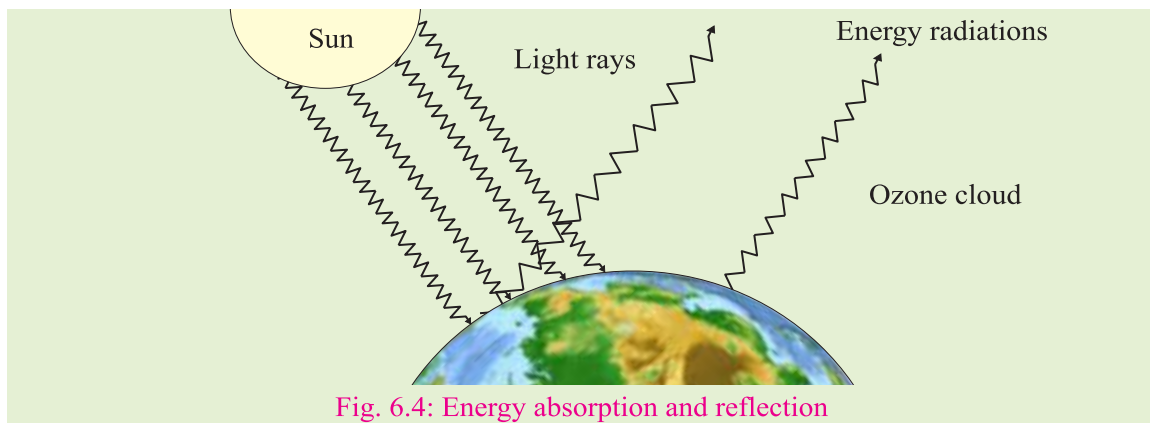

Fig. 6.4: Energy absorption and reflection

The hot earth reflects the absorbed radiations in the form of long wave length heat radiations. Carbon dioxide and water vapour allow radiations coming from the sun to pass through. However, they prevent the reflected heat radiations from going back into the space. Thus the atmospheric temperature is maintained.

## Greenhouse Effect

Greenhouse is a room made up of glass. It is used to grow plants. Solar radiations (short wave length) can enter through the glass into the greenhouse but heat waves (long wave length) cannot go out of the greenhouse. This results in higher temperature inside the greenhouse. This phenomenon is called **greenhouse effect**.

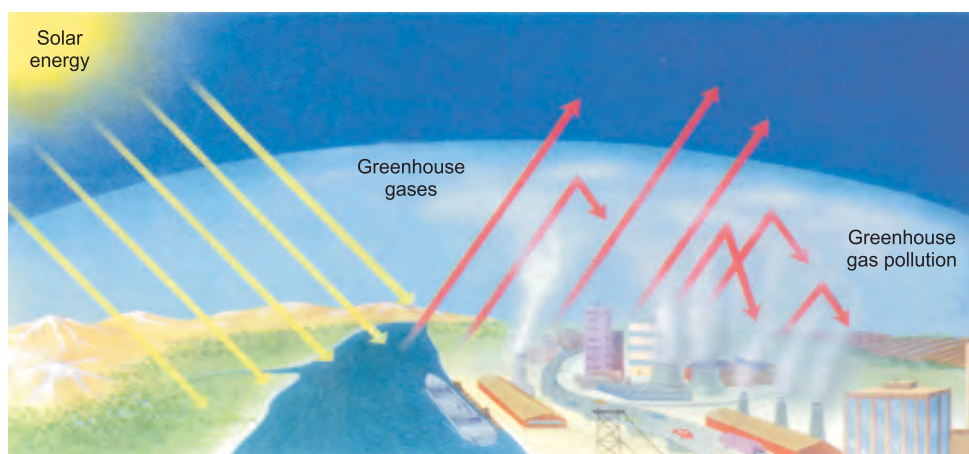

Fig. 6.5: Green house effect

Atmospheric pollution due to industrialization in modern times has increased the proportion of carbon dioxide, chlorofluorocarbons and methane in air. These gases produce greenhouse effect. Because of greenhouse effect global temperature is increasing. This is called **global warming**.

Greenhouse effect and global warming have many undesirable effects. For example:

1. Earth's climate and weathers may change.
2. Melting of ice caps on poles and mountains and excessive rains may raise sea level. Many coastal areas may go under sea.

## Effects of Human Activities on Climate, Winds and Weather

Are we humans really bringing such changes in the atmosphere that may change global climate? Shall increasing greenhouse gases due to human activities lead to global warming?

Shall these changes lead to alteration in air circulation patterns, intensity of rains and climatic conditions. And shall these changes become intolerable for humans and other living things?

A close relationship has been observed between the increasing global temperature and increasing levels of greenhouse gases during the second half of the 20<sup>th</sup> century. Some experts of environment say that in future heat will become unbearable. Deserts will expand. Some areas will have more rains and floods.

Sea level will rise due to melting of ice. Also climatic changes will lead to extinction of many present day species.

## 6.2 Environmental Pollution.

Pollution means, any change in the properties of air, water or land which have undesired effects on man or other living things or may have such effects in future.

Human activities in the modern industrial world produce a large amount of wastes. Different gases (carbon dioxide, carbon monoxide, sulphur dioxide, oxides of nitrogen etc.), smoke, useless particles and toxic water are released from factories and vehicles. Human excreta, left over food stuff and domestic trash is also included in wastes causing pollution. Fertilizers and pesticides are used to increase agricultural production. They are washed off by water or blown away with wind and cause environmental pollution. Any excess or waste substance that can cause pollution is called a pollutant.

### Types of Pollution

According to the part of the environment being affected pollution is categorized into three types:

1. Air or atmospheric pollution
2. Water pollution
3. Land pollution

#### 1. Air pollution

Air is considered polluted when a change occurs in its composition or quality. This change in quality of the air is due to the addition of different gases, smoke and particles. Some important sources of these materials are:

- (i) Burning of fuels in factories, vehicles and fuel driven power stations.
- (ii) Materials released during the preparation of goods in the factories or coming out

stacks of furnaces. For example asbestos fibres, particles of lead and zinc.

- (iii) Release of chlorofluorocarbons from spray cans and during the preparation of packing foam.
- (iv) Dust, chemical fertilizers and insecticides blown into the atmosphere by wind.



Fig. 6.6: Air pollution

**Effects:** Air pollution affects plant, animal and human life in many ways:

Hydrocarbons, carbon monoxides, lead particles and asbestos fibres may cause cancer and respiratory and eye diseases.

A brown coloured gas called nitrogen peroxide combines with some other gases in the presence of light and form a compound called

smog. Smog causes lung diseases. Other than this, the things cannot be seen clearly.



Fig. 6.7: Acid rain

Excess of carbon dioxide in the atmosphere produces greenhouse effect. Earth's temperature is said to be rising due to the greenhouse effect. Sulphur dioxide and oxides of nitrogen in air cause acid rain, which damages plants, aquatic animals and buildings.





Fig. 6.8: The things can not be seen clearly due to smog

## 2. Water pollution

Water pollution is generally caused when industrial wastes, trash and sewage from cities is discharged into the water bodies like rivers, streams, ponds, lakes and oceans. Water pollution is a problem chiefly of industrialized countries but now a days many developing countries like Pakistan are also facing this problem.

Heavy metals like chromium, lead, mercury are produced as wastes in the leather, textile, plastic and other chemical factories. They get entry into the water bodies. When heavy metals and other toxic materials enter into bodies of living organisms, they may cause cancer and various other diseases.



Fig. 6.9: Water pollution

Sewage and domestic wastes contain left over food, detergents and human excreta. On entering into the water bodies they increase the concentration of salts and organic matter in water. This results in the decrease of amount of oxygen in water. Consequently, aquatic life (fish and aquatic plants) is badly affected. Fishes have disappeared from Nallah Dek and river Ravi near Lahore due to water pollution.

In addition to the above effects, polluted water becomes unfit for drinking as well as for domestic and industrial use.

Disease causing germs are another serious cause of water pollution. They cause cholera, typhoid and disease due to worms of digestive tract. Especially the children are affected by these diseases.

Chemical fertilizers and pesticides sprayed on crops are washed off with rain water and enter into rivers, streams and underground water. Oil spills from oil tankers have dangerous effects on the life of marine plants and animals as they form thick layer of oil on the surface of sea water. In July 27, 2003 a Greek oil tanker Tasman Spirit met accident near Karachi harbour and split up into two sections. About 20,000 tons of crude oil spilled into the sea, most of it reaching the Clifton beach. This oil spill badly affected coast line environment, marine life and recreational spots like Manora. Dumping of nuclear wastes into the sea or oceans may become another source of water pollution.

### 3. Land pollution.

Municipal trash, sewage sludge, agricultural wastes and chemicals from industries are the major sources of land pollution.



Fig. 6.10: Land pollution



Solid wastes are often disposed of either by burning in or dumping into the ground. From the environmental view point both these methods are not completely safe. Germs and toxic substances from heaps of trash enter into the environment or food by wind, water or flies. Germs and toxic substances thus carried cause a number of diseases. Waste polythene bags are not decomposed and are often seen flying in streets and open places. They also cause choking of drains.

### Measures to Reduce Pollution

Pollution and environmental degradation can only be prevented if individuals, society and government feel their responsibility. Everyone should be aware of and sensitive to the environmental problems. All should play an active role in the solution of these problems.



Fig. 6.11: Recycling of the materials

Agriculture and industry are essential for economic development and better living but keeping pollution to the minimum level is also necessary, so that human beings, other organisms (Plants, Animals) and thus future generations live a healthy and happy life.

We should:

- i. not throw waste articles here and there or into the water bodies. Dispose of the things properly.
- ii. make minimum and only necessary use of resources. Do not waste them.
- iii. prefer things that can be reused. Materials can also be recycled.
- iv. prefer things which are biodegradable i.e. they can easily be decomposed into simple harmless substances by the action of microorganisms.
- v. throw domestic industrial and hospital wastes into air, land or water only after treating to make them harmless.
- vi. at government level, minimum environmental standard must be set and enforced. The owners of industries and factories be bound to the measures that should minimize pollution.
- v. Implant more and more trees and should take care of them.

## 6.3 Minerals and Fossil Fuels

Development and progress of a country depends upon what type of land, water, minerals, forests and wild life etc are present there and how they are being utilized. All the things mentioned above are called resources. God has blessed Pakistan with all types of resources which are basis for the development of any nation.

### Fossil Fuels

Coal, oil and gas are called fossil fuels. Energy required for transport, power generation, agriculture and industry comes mainly from these sources. They are called fossil fuels because they were formed from the remains of plants and animals of remote past, which were buried under the earth. With the passage of time they changed into coal, oil and gas due to excessive pressure and temperature in the earth.

#### Coal

It is one of the oldest sources for obtaining thermal (heat) power. Coal was formed millions of years ago by burying of trees and remains of plants growing in marshes. In Pakistan coal is mostly used in brick kilns. However, it is also being used in production of electricity.

#### Petroleum

Petroleum is a liquid fossil fuel. It is formed in shallow seas from marine plants and animal remains, which were buried under earth and changed later on into petroleum due to pressure and high temperature. Gas was also formed along with petroleum.

Petroleum is one of the most important resource in the modern times. Various products are obtained by refining crude oil pumped out from the earth. Gasoline (Petrol), diesel, furnace oil and kerosene oil all are petroleum products used as fuels in vehicles, ships, power station, industries and homes. Grease, asphalt, synthetic fibre ( such as nylon, polyester), and plastic are some other petroleum products.

#### Natural gas

Natural gas is a mixture of different gases including methane, ethane, propane etc. Large deposits of natural gas exist in Pakistan. Natural gas, like petroleum and coal, is a major source of energy. It is used in electricity generation in power plants, production of cement and chemical fertilizers, industries and homes for heating and cooking. Many vehicles now a days are also being run on compressed natural gas.

### Effects of fossil fuels on environment

Although fossil fuels are a cheap and convenient source of energy but at the same time these are creating many environmental problems. As already discussed under air pollution, burning of fossil fuel produces smoke and a number of gases, which cause environmental pollution. Large areas of fertile land, forests and natural habitats of many animals are destroyed during exploration and drilling of coal and oil.

### Minerals

Minerals include those elements (e.g. gold, iron, copper) and compounds (e.g. gypsum, mica) which are found in solid state in the earth crust and are important for human use. Mostly minerals are in rock form. The rocks from which minerals can be obtained are called **ores**.

Minerals are important for us in many ways. Metals (iron, silver, copper, aluminum etc.) and non-metals (sulphur, lime stone, granite etc.) have become part of our daily life. Gypsum is used in cement and plaster making and for reclamation of saline (salt affected) soils. Chromium is obtained from chromite. In addition to making alloys chromium is used in many industries. Gemstone is source of gems and diamonds. Silicon is obtained as silica ( $\text{SiO}_2$ ), which is used in glass making. Now a days silicon is used in making microprocessors of computers.

God has gifted Pakistan with great minerals wealth. Especially Balochistan is rich in minerals.

### Conservation of Natural Resources (fossils fuels and minerals)

Use of natural resources is essential for industrial development, progress, prosperity and better quality of life. However, it is also a fact that fossil fuels and mineral are non-renewable resources. They are called **non-renewable resources** because either they cannot be reproduced or it takes long time to reform. For example, millions of years are needed for the formation of fossil fuels. Also, the amount of minerals on earth is limited. They may end up soon if their excessive use is continued. Resources must be conserved for future use. Measures like recycling of used materials, substitution (use of alternatives) and reuse of articles of common use may be adopted in this regard.

## 6.4 Agriculture and Crops of Pakistan

Food is the basic human need. It is fulfilled by agriculture as are clothing, housing and many other requirements. Increasing human population at global level demands increase in agricultural production.

Pakistan is an agricultural country. About 60 percent of its population depends directly or indirectly on agriculture. Almighty Allah has blessed Pakistan with large areas of fertile agricultural land. We also have an extensive and world's one of the best canal irrigation system. Pakistan has attained self-sufficiency in cereal foods (wheat, rice) and fruits. This has become possible because of favorable climate, application of chemical fertilizers, and insecticides, mechanized farming, and efforts of our hard working farmers. Certain cash crops, such as cotton, rice and fruits, are also being produced in substantial quantities. These cash crops are a big source of earning foreign exchange. In spite of these successes, there is still need for growing and increasing the production of some crops e.g. pulses and crops yielding edible oils.

### Mechanized Farming and Production Trends

Till recently, farming in Pakistan was labour-intensive, depending mainly upon muscle power. However, since last few decades production trends have emerged in agriculture. This means that now the crops are not grown only for substantive living but also for the purpose of export sale and earning money. Mechanized farming is getting popular in order to obtain more crop yield. Irrigation by tube wells, ploughing and tilling of land by tractors, and the use of harvester and threshers are common practice these days.



Fig. 6.12: Mechanized farming

Many disease-resistant varieties have been produced through research in agriculture. Use of chemical fertilizers and insecticides is also increasing and become popular among the farmers. All these trends have resulted in increased crop production leading to betterment in the economic and social life of our people.

On the other hand, some environmental problems have also surfaced as a consequence of these development. Canals and distributors are often not lined with bricks and so water seeps down from them. This results in rising water table. Consequently the irrigated areas are becoming victim to the twin menace of water-logging and salinity. As a result of this problem large area of fertile land has been rendered unfit for agriculture. Insecticides and fertilizer application is adding to environmental pollution. The number of insects that have become resistant to insecticides and pesticides has increased. Cultivation of the same crop year after has

led to decreased soil fertility. Sustainable agriculture, which incorporates rotation of crops, conservation of soil and land, and minimum use of fertilizer is the need of the day.

## 6.5 Dairy and Poultry Farming

Balanced diet is a requirement for proper development and good health. Milk, butter, cheese, meat and eggs are important constituents of balanced diet, these constituents are obtained from cattle (cow, buffalo and goat), chicken and fish.

Man has been raising domestic animals since ancient times. However, in recent times dairy farming, cattle farming and poultry farming is carried out on scientific principles. Using the knowledge of biology, improved varieties of cattle and chicken have been produced that give better yields of milk, meat and eggs. These animals are also raised and taken care of on scientific lines. Now a days we do not depend for fish on natural sources such as rivers and oceans, but instead fish are grown in specially built fish farms.

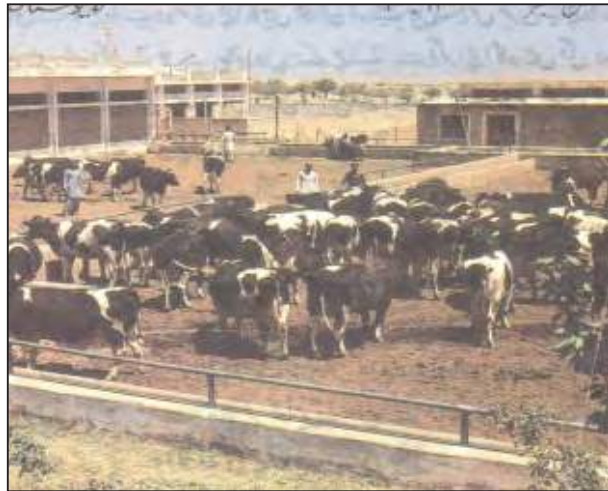

Fig. 6.13: Dairy farm

### Dairy Products

Sufficient quantity of milk and butter is produced in Pakistan. However, large bulk of this milk and butter is not processed and packed properly. That is why country needs are not adequately fulfilled. Due to the application of biotechnology standard of dairy products has much improved.

### Poultry Products

Protein rich food like meat and eggs is obtained from chicken.



Fig. 6.14: Poultry farm



Development of poultry farming on scientific lines has helped greatly in increasing overall production of food in the country.

### Fisheries

Fish is a source of highly nutrient diet. Fish are found in streams, rivers, lakes and oceans. Rahu, thalah and trout are fishes of our fresh water streams. Their meat is very delicious and full of nutrients. Modern aquaculture techniques have led to many fold increase in fish production.

## 6.6 Wildlife and National Parks

All non-cultivated plants and wild (non-domesticated) animals of an area are called wildlife of that area. As wildlife is integral part of the natural environment of an area, elimination of species or decrease in its population may upset the natural balance.

### Importance of Wildlife.

- i. Many products obtained from wildlife are used in our homes, industry and agriculture. Food, timber and medicines are few examples.
- ii. Wildlife maintains balance in nature.
- iii. Wildlife satisfies our aesthetic sense. Colorful flowers and plants, forests, beautiful animals and hunting of game animals add to our happiness.
- iv. Wildlife (plants and animals) of today will determine what types of plants and animals will be found in future.

### Endangered Species.

About 200 species of mammals, 600 kinds of birds, 150 types of reptiles and 700 different types of fishes are found in Pakistan. Destruction of habitats as a result of human activities and over-hunting is resulting in the local extinction of many types of wildlife.

Those organisms which are threatened of extinction are called **endangered species**.

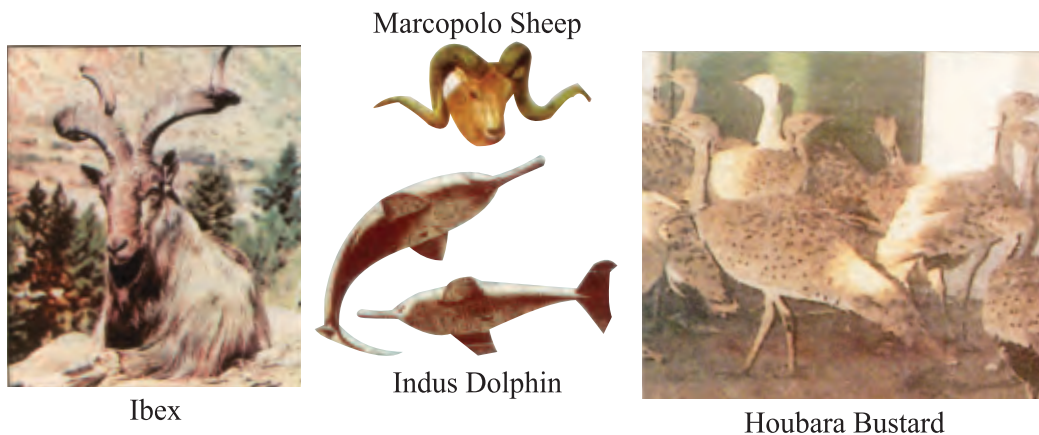

Fig. 6.15: Endangered species

Cheetah, musk deer, wild ass, alligator and red-headed goose have disappeared before our eyes. Morcopolo sheep, Musk deer, Snow leopard, Ibex of Suleman range, Urial of Punjab, Houbara bustard, Crocodile, Indus river blind dolphin, Balochistan bear, sea Turtle and Gizzale are among the animals which are listed endangered in Pakistan.

### Conservation of wildlife

Wildlife can be saved from extinction if their habitats are re-established. For this purpose certain areas are marked and specified for wildlife. Such areas are called wildlife reserves and wildlife parks.

For the sake of wildlife conservation it becomes very necessary to ban hunting of some animals or to restrict their hunting or trading. Laws exist in this regard but they need to be enforced strongly.

### National Parks

National Parks play an important role in the conservation of wildlife. National parks are natural areas which are kept in their original setting along with their natural plants and animals for future generation. All sort of human interference except for educational and research purpose is strictly prohibited.



Fig. 6.16: National park near Bahawalpur

## 6.7 Effects of Rising Population on Environment

### The Population

The total number of people living in an area at a particular time is called **population**. For example in 1998, 130.5 million people, were living in Pakistan. We call it the population of Pakistan in 1998.

### Increase in Population

Human population at global level is fastly increasing in the modern period. It can be easily judged from the fact that population on earth has doubled during the last forty one years



Fig. 6.17: Increase in population



Population growth rate in under-developed countries is much higher than that of developed countries. For example, at present average annual population growth rate in Pakistan is 2.6 percent whereas it is 0.6 percent in the U.S.A. and 0.2 percent in Britain and Japan. This growth rate (2.6%) is higher even than the SAARC countries.

### Population Growth and Balance in Nature

Resources in any ecosystem are limited. Thus, every ecosystem has a capacity to support (provide requirements of housing, food and protection) a definite number of individuals. If population exceeds the carrying capacity of an ecosystem, the population has to face problems. In case of human populations we can say that faster growth in population of an area affects the economic progress of that area. Resources come under pressure and development stops.

### Population and Environmental Problems

Rising populations affect the environment in many ways. Consequently, a number of environmental problems of physical, economic and social nature arise. Basic necessities of life such as clean air, water, housing and food are not properly fulfilled. Facilities of health and education are not available for all. In spite of all out efforts for development quality of life falls. Increase in population also produces social-cultural and moral problem. Crime, violence, uncertainty, hunger and sense of deprivation cast very negative effects on society.

Some important environmental problems are poverty; poor quality of life; pollution; degradation of land; destruction of forests; expansion of cities; migration.

People come to live in an area for the sake of better job opportunities, more health and educational facilities, and for socio-political reasons. This act is called **migration**. Migration from rural to urban areas leads to huge increase in city population. Consequently, many people are forced to live in slums.



Fig. 6.18: Slums

The quality of life of a nation is judged by certain indicators, which are education, health, nutrition, housing and other facilities such as clean water, electricity. Due to increased population and shortage of resources, number of illiterate children is increasing day by day.

Forests are cleared to fulfill the needs of growing population. This action leads to unfavourable climatic changes. Soil erosion occurs and fertile agricultural land is wasted.

## IMPORTANT POINTS

- Atmosphere of the earth is like an envelope, which is very important for life on earth. It maintains temperature of the earth and prevents harmful solar radiation from reaching the earth.
- Atmosphere consists of four layers. Ozone present in the stratosphere stops ultra violet radiation. Destruction of ozone layer as a result of human activities is causing diseases like cancer.
- Increased levels of carbon dioxide and greenhouse gases produces greenhouse effect, as a result of which global temperature is rising.
- Industrialization, agriculture and excessive use of resources has created environmental problems like pollution. It has become necessary to take such measures which may conserve environment and resources with out hampering economic development.
- Use of minerals and fossil fuel is essential for industrial developments, economic progress and better quality of life. However, use of minerals and fossil fuels is also creating pollution of air, water and land.
- Minerals and fossils fuel are non-renewable resources. They may finish soon. They must be preserved for use by future generation. Limited use of resources, recycling, use of alternatives and re-use of used articles are some methods of conservation.
- Mechanized farming is practiced for higher yields. Improved crops have been produced. Chemical fertilizers and pesticides are important characteristic of modern agriculture.
- Scientifically operated dairy, poultry and fish farming has helped in over-coming food shortage.
- Many species have become endangered due to wildlife habitat destruction and unnecessary and over-hunting. Wildlife reserves and parks are established for conservation of wild life. These are the areas where organisms are provided their natural environment and human interference is banned.

- Modern industrialized era has seen explosive increase in world population. Population growth rate is specially very high in developing countries. Fast rate of population growth has led to many environmental problems of physical, economic and social nature. Quality of human life has been adversely affected.

## GLOSSARY

<b>Atmosphere:</b>	An envelope of gases that surrounds earth.
<b>Ozone:</b>	A gas containing three oxygen atoms per molecule.
<b>Global Warming:</b>	An increase in earth's surface temperature caused by increase in greenhouse gases.
<b>Greenhouse gases:</b>	Gases in the atmosphere that trap heat.
<b>Chlorofluorocarbon (CFCs):</b>	A compound of carbon, chlorine, and fluorine used in refrigerators, air conditioners, aerosol cans, and in the production of foam.
<b>Smog:</b>	A mixture of nitrogen peroxide, water vapour and some other gases.
<b>Recycling:</b>	Production of new useful articles from used materials.
<b>Fossil fuel:</b>	Fuel derived from the remains of organisms that lived long ago.
<b>Wildlife:</b>	Naturally occurring organisms of an area.
<b>Wildlife reserve:</b>	Area reserved for wildlife conservation.

## QUESTIONS

- Q No. 1      **Fill in the blanks:**
- Atmosphere is an \_\_\_\_\_ of gases that covers the earth from all sides
  - Ozone prevents \_\_\_\_\_ from reaching the earth.
  - Temperature of the thermosphere may be upto \_\_\_\_\_.
  - Radiation of \_\_\_\_\_ wavelength can not go out of greenhouse.
  - Substances that cause pollution of the environment are called \_\_\_\_\_
  - Coal, oil and gas are called \_\_\_\_\_.
  - Fossil fuels and minerals are \_\_\_\_\_ resources.
  - One reason for the extinction of many species is \_\_\_\_\_ destruction.

- (ix) Areas reserves for wildlife are called \_\_\_\_\_.
- (x) Moving out from an area and settling in another area is called. \_\_\_\_\_

**Q No. 2** Four answers have been provided for each question. Encircle the right answer.

- (i) Thickness of atmosphere is
- (a) 200 km (b) 1000 km  
(c) 1200 km (d) 1600 km
- (ii) The proportion of carbon dioxide in air is
- (a) 40 percent (b) 0.4 percents  
(c) 0.04 percent (d) 0.004 percent
- (iii) Ozone forms a protective layer in
- (a) Troposphere (b) Stratosphere  
(c) Mesosphere (d) Thermosphere
- (iv) Major cause of depletion of ozone layer is
- (a) Oxygen (b) Hydrogen  
(c) Chlorofluorocarbons (d) Hydrocarbon
- (v) About \_\_\_\_\_percent population of Pakistan is dependent upon agriculture
- (a) 90% (b) 80%  
(c) 60% (d) 50%
- (vi) The total number of persons living in an area is called
- (a) Species (b) Population  
(c) Community (d) Habitat
- (vii) Pakistan's population in 1998 was \_\_\_\_\_.
- (a) 130.5 Million (b) 13.5 Million  
(c) 135 Million (d) 0.135 Million
- (viii) At present population growth rate is 2.6 percent, in how many years the population of Pakistan will double?

- (a) 47 years                      (b) 37 years  
(c) 27 years                      (d) 17 years

**Q No. 3      Short questions**

- (i) Define
- (a) Pollution                      (b) Pollutants  
(c) Recycling                      (d) Endangered species
- (ii) Write names of the four layers of atmosphere.
- (iii) Write any two effects of greenhouse effect on environment.
- (iv) Write two methods of conservation of natural resources.
- (v) Write two benefits of wildlife .

**Q No. 4**      Explain composition and different layers of atmosphere.

**Q No. 5**      Write a note on depletion of ozone layer.

**Q No. 6**      What is meant by greenhouse effect? Describe its causes and effects on environment.

**Q No. 7**      How human activities affect environment?

**Q No. 8**      Write down causes, effects and measures of controlling aquatic pollution.

**Q No. 9**      Explain use and environmental effects of fossil fuels.

**Q No. 10**     Write a note on conservation of resources.

**Q No. 11**     Write brief notes on: -

- (a) Mechanized farming and modern trends in agriculture.  
(b) Dairy, poultry and fish farming.  
(c) Wildlife conservation and National parks .  
(d) Importance of wildlife.

**Q No. 12**     Explain environmental problems arising due to increase in population.

# 7 ENERGY

In this chapter you will learn:

- Work and Energy
- Different Forms of Energy
- Interconversion of Energy
- Demand of Energy
- Production of Electrical Energy
- Measurement of Energy
- Energy and the Environment
- Degradation of Environment
- Nuclear Fuel Hazards
- Conservation of Energy

Energy is the essential part of our lives. Energy is used in our daily life in different forms. We do many tasks from dawn till dark. For this, we have to spend energy. When we get tired after working we feel hungry, we take food which provides us energy. We cannot do any thing without light. Light is also a form of energy. We require heat to warm ourselves in winter. Heat is yet another form of energy. In summers, we use fans, refrigerators and air-conditioners for cooling. Besides them, we use many other appliances all of them work with electricity. Electricity provides them energy to run. All of motorbikes, heavy vehicles, aeroplanes and ships consume fuel, which provides energy. As our usage for machines increases, our requirement of energy also increases.



There is an incredible amount of energy in big tides of sea. There is a positive and negative prospective of this.

## 7.1 Work and Energy

For the proper definition of energy, we should first learn about work.

### Work

Suppose a person works in an office for the whole day or a worker holds up a wooden box for half an hour. Apparently both of them have performed work, but in the scientific term this would not be considered as work. There is a proper definition of work in Physics. When a force acts on a body and the body is displaced, then the force is said to have done work on the body.



Fig. 7.1

**Work is the product of force and distance in the direction of force.**

i.e.,  $\text{Work} = \text{Force} \times \text{Distance covered in the direction of force}$

The unit of work is joule (J).

The ability of a body to do work is known as energy. Energy is defined as:

**Energy is the ability to do work.**

Since the unit for work is joule therefore, the unit for energy is also joule.

## 7.2 Different Forms of Energy

There are many forms of energy. Some common forms of energy are as follows:

### (i) Kinetic Energy

When a body is moving, it possesses energy. Because a force is acting on it and it also covers some distance. It means that the body has the ability to do work.

**Energy possessed by a body due to its motion is known as kinetic energy.**



Fig. 7.2



When a cricket ball is hit with a bat, the ball runs fast. We say that the running ball possesses kinetic energy. But we observe that ball stops after covering some distance, then where did the kinetic energy go? (Fig: 7.2). Actually a force acts on the moving ball in opposite direction, which is ground friction. This frictional force causes the ball to stop. Here the friction of air is negligible.

The ball has to apply the same amount of force opposite to the frictional force to keep its motion. Thus the ball is doing work against friction, which is the product of its force and the distance covered. All of the kinetic energy of the ball is consumed in doing work and the ball eventually stops. This proves that a body can do work due to kinetic energy.

The kinetic energy of a body depends upon its mass and speed. The more the mass or speed of a body the more is its kinetic energy.

### (ii) Potential Energy

A stone lying on the ground does not possess the ability to do work. If that stone has to be moved up to a certain height, a force equal to the gravitational force will have to be applied on it. In other words, work has to be done on it. The work done will be stored in the stone as energy and it will gain the ability to do work. Now if the stone is released at this height, it will fall to the ground by itself doing work. The energy possessed by the stone at height is the potential energy.

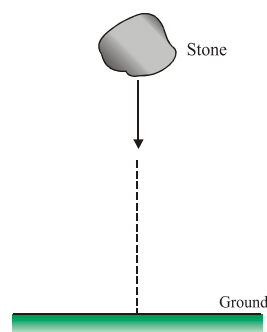

Fig. 7.3

**Energy possessed by a body due to its position is known as potential energy.**

### (iii) Elastic Potential Energy

When a spring is pressed, an elastic potential energy is stored in it. When it is released, it shoots up by itself and possesses the ability to do work. The energy stored in a body by pressing, stretching or twisting is known as elastic potential energy. If a piece of rubber or the rubber of a slingshot is stretched an elastic potential energy is stored in it. (Fig: 7.4).

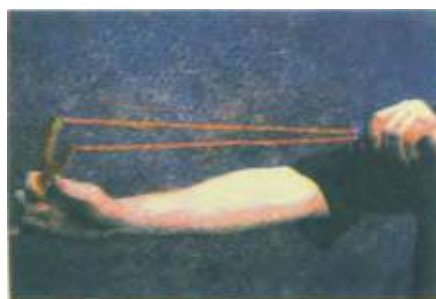

Fig. 7.4

### (iv) Chemical Energy

Sometimes, energy is emitted during chemical reactions. The source of this energy is the chemical bonds between atoms. When these bonds break, energy is released. In cells and batteries, chemical energy transforms into electrical energy. The energy obtained by burning fuel in cars is also chemical energy. The energy obtained by our bodies by consuming food is also chemical energy.

**(v) Heat Energy**

Heat is also a form of energy. Heat energy is due to the movement of the molecules of bodies. The faster the movement of molecules, the greater is the heat energy. The Sun is the largest source of heat energy. Burning of fuel is another source of heat energy. When current passes through the element of an electric heater or an electric iron, heat is produced.

**(vi) Light energy**

Light is another form of energy. We can see things with the help of light. Like heat, the largest source of light is also Sun. When current passes through a bulb, it emits light. When electrons revolving around the nucleus jump from a higher energy orbit to a lower energy orbit, light is emitted. The leaves of plants prepare food by photosynthesis. This process can not be done without light. All creatures on Earth are directly or indirectly dependent upon the food made by plants.

**(vii) Electrical Energy**

Electrical energy is the energy of moving charges. Electrical energy is used on large scale, because it can be easily achieved and transferred from one place to another and can also be transformed into different forms of energy. We use energy obtained from different sources by converting it into electrical energy. For this purpose, power stations are built that supply electricity at far off places.

**(viii) Nuclear Energy**

Nuclear energy is obtained by breaking the nuclei of heavy atoms. The process is called nuclear fission. This process is done in a nuclear reactor where energy is released in the form of heat. This heat can be used to produce electricity. Energy is also released when the nuclei of small atoms fuse together. This is known as nuclear fusion. It is also nuclear energy. The heat and light coming from the Sun are released due to this process.

**Do you know?**

The energy for destruction in the atom bomb is also nuclear energy

**7.3 Interconversion of Energy**

We use energy daily in the form of heat, light and electricity. As a matter of fact, energy changes its form in different conditions. When a body is taken at a height, gravitational potential energy is stored in it. When the body is dropped, the gravitational potential energy converts into kinetic energy. The chemical reaction in cells or batteries convert chemical energy into electrical energy. When current passes through a bulb, it emits light and heat. The electrical energy in a bulb is converted into heat and light. The food you eat possesses chemical potential energy. Your body has the capability to transform potential energy into heat that maintains your temperature. The body also converts some chemical energy into kinetic energy of blood so that you can live.

Some energy in the body is also converted into electrochemical energy on which your nervous system works.



The chemical energy is present as potential energy in the muscles of cat.



When the cat leaps for its prey then the energy is converted into kinetic energy.

The example given above proves that one form of energy can be transformed to another form, but the total energy is always conserved. This is known as the law of conservation of energy. The definition of the law is as follows:

**Energy can neither be created nor destroyed.**

In other words, the total energy of an isolated system always remains constant, although it is transformed from one form to the other. When we say that energy is consumed, we actually mean that it is changed from one form to the other or it is transferred from one place to the other. In most of the cases, energy is eventually transformed to heat.

## 7.4 Demand of Energy

50 years ago, there was no electricity in most of the houses. People used to illuminate their houses by candles, lanterns or other such things. Instead of electric fans, hand held fans were used. There was no concept of things like refrigerator or television. But, with the advancement of science, people got many comforts of life. Today not only cities, but villages also have been provided electricity. The increase in consumption of electricity is not confined to houses only, but the dependence of industries on electricity has increased manifold. Not only large scale factories but small workshops are also using machines. The use of electricity in agriculture is also increasing. Earlier, people used to wait for rain or get water from wells, but now tubewells are run by electricity. Many barren lands have been irrigated by this. The yield per acre has increased. In many other fields of life, the consumption of energy is constantly increasing. It is required to discover more resources of energy and the present resources utilized in a better way.

## 7.5 Production of Electrical Energy

We use energy in the form of heat, light and motion etc. but the most important use of energy is in the form of electrical energy. We change electrical energy in the form of heat, light and motion according to the demand. The traditional methods to make electricity involve the use of running water, burning fuel and nuclear energy, but these resources are not sufficient to keep

with the increasing demand of electricity. We have to find new resources. Some of the traditional and non-traditional sources of producing electricity are as follows:

### Traditional Methods of Production of Electricity

#### (i) Hydroelectric Power

The conversion of kinetic energy of running water to electrical energy is known as hydroelectric power. Water is stored in a high lake or reservoir. At a height, gravitational potential energy is stored in the water. When water falls from height, the potential energy is changed into kinetic energy.

Tunnels are made to bring water from the reservoir to a lower place. The kinetic energy of running water turns the turbines which in turn runs the electric generators. By this method electricity is produced. (Fig.7.5). In fact, electrical energy is that potential energy of water which is obtained from falling water. There is no heat, smoke or gas pollution in this method. Moreover, water from the power station is used for agricultural purposes.

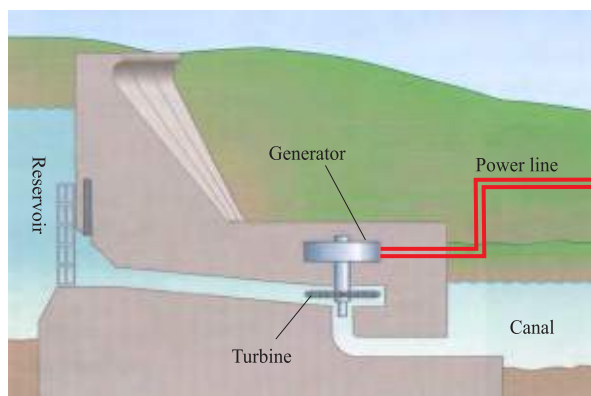

Fig. 7.5: Hydroelectric Power

#### (ii) Thermal Power

In this method, coal, oil and natural gas are burnt. These are known as fossil fuels. The remainings of plants and animals buried for millions of years under the Earth are changed into fossil fuels. These fuels are in a limited quantity. It will take millions of years to form new fuels once the old ones are exhausted. The chemical potential energy is stored in fossil fuels. The burning of these fuels gives out heat which is used to generate steam that turns the turbines to produce electricity. (Fig. 7.6).

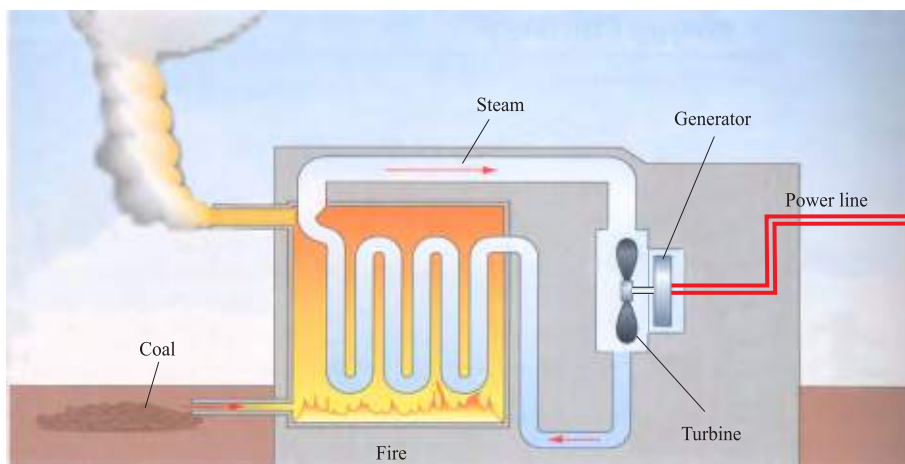

Fig. 7.6: Thermal Power

### (iii) Nuclear Power

Many developing and developed countries generate electricity by nuclear energy. In Pakistan, there are nuclear power stations which are built at Karachi and Chashma.

The source of nuclear is the nucleus of an atom in which energy is stored. When the nucleus of a heavy atom is broken, a large amount of energy in the form of heat is released. This process is known as nuclear fission. Uranium-235 or Plutonium is used as fuel in nuclear fission. The whole process of nuclear fission is done in a nuclear reactor which is protected by a concrete wall. The heat obtained by nuclear fission is used to change water to steam, which in turn runs the electric generators. In this way electricity is produced. Figure (7.7) shows different parts of nuclear power station.

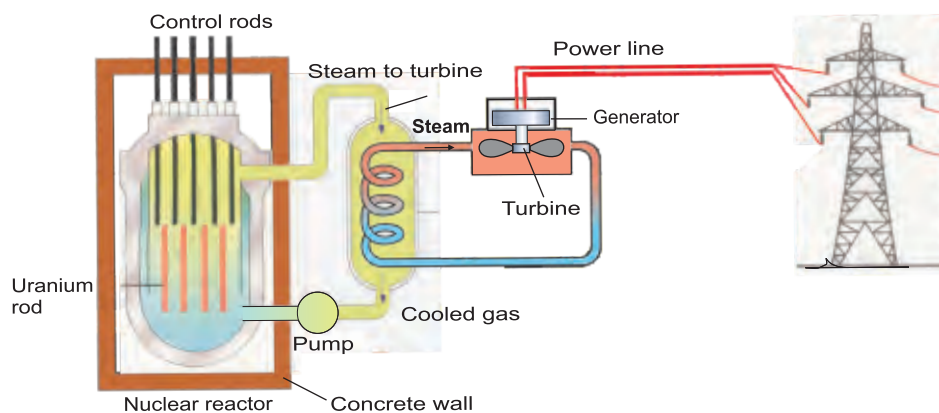

Fig. 7.7: Nuclear Power Station

### Non-traditional methods of producing electricity

We can not depend on the traditional methods of getting energy for long. We should take all possible steps to promote new methods so that we may have sufficient and cheap resources to fulfil our needs. Some of the non-traditional methods of producing electricity are given below:

#### (i) Solar Power

You must have seen calculators that run without cells. The photocells installed in them transform light to electricity. Solar energy is the energy obtained from the Sun. Usually, the solar energy falling on the atmosphere of Earth is almost 1.4 kilowatt per square metre. The dust particles, water vapours and gases present in the atmosphere absorb, reflect or disperse most of the energy. But still about 1 kilowatt of energy per square metre reaches the Earth's surface. Solar energy is used in two ways. In one way solar pannels absorb heat. These consist of large plates that have been painted black.



Fig. 7.8 : Solar Power



The absorbed heat is used to heat houses or run a water heating system. Steam can also be produced by using reflectors or lenses that runs the turbines of generators and produce electricity (Fig. 7.8).

In the second method, sunlight is directly transformed to electricity with the help of solar cells. The voltage of one cell is very small but for practical use we can connect many cells in series to get large voltage (Fig. 7.9). At present this method is expensive but it is hoped to get it cheaper in future.



Fig. 7.9: Solar Cells

### (ii) Wind Power

In wind power, kinetic energy of fast blowing air is used to produce electricity. A wind mill consists of three or four wings mounted on top of a pole. These are called turbines of wind mill. When turbines turn due to air, we can make use of this energy in many ways. Traditional wind mill is used to grind grains and to fetch water from the well. But the modern wind mill is used to run generators that produce electricity. A big farm of many wind mills is made to produce electricity. This is capable of running huge generators.



Fig. 7.10: Wind Form

### (iii) Tidal Power

Big tides of water are generated in the sea due to attraction of moon. The energy of these tides is known as tidal energy. The tidal energy can be used to produce electricity. A dam is constructed for this. At the arrival of high tide, water is trapped in the dam. On return of tide, trapped water is allowed to flow out in such a way that it turns the turbine. The generator joined to the turbine produces electricity. The high tide moving towards the dam is also used to turn the turbine (Fig. 7.11).



Fig. 7.11: Tidal Power

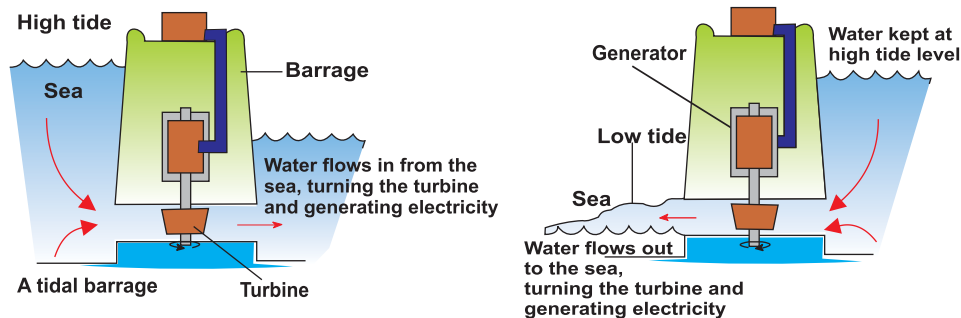

Fig. 7.12: Tidal Power

#### (iv) Geothermal Power

To make use of energy deep under the Earth in the form of hot water or steam is known as geothermal. About 10 km below the surface of Earth, there are hot semi-molten rocks at some places. The temperature of these rocks is 200°C or above. Where there is water present over such rocks, it comes out to the surface of Earth in the form of fountains, geysers and steam. The steam is used to run generators. Where there is no water over tunnels are drilled there up to the rocks and cold water is pumped through one tunnel, which comes out in the form of steam through the second tunnel. The steam runs the generator, which produces electricity (Fig: 7.13).

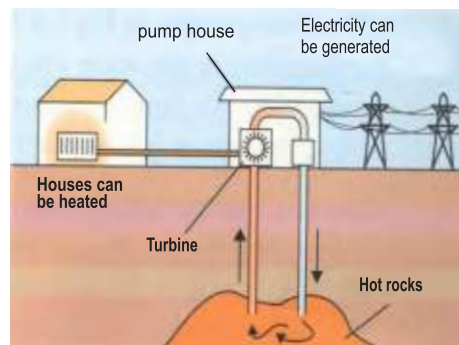

Fig. 7.13: Geothermal Power



Fig. 7.14: Geothermal Station

#### Production of Electricity from Biomass and Solid Waste

Biomass is a natural source of energy. It consists of all organic materials such as residue of crops, trees, plants, vegetable peels, animal dung and sewage etc. Sewage is that dirt which is remained after straining dirty water. The fuel obtained by biomass is of two types. Ethanol (alcohol) is produced by the alcoholic fermentation of biomass, this is a substitute of gasoline. Another type of fermentation gives out methane gas, which is the substitute of natural gas. This is called biogas. It can be burnt or used to produce electricity.



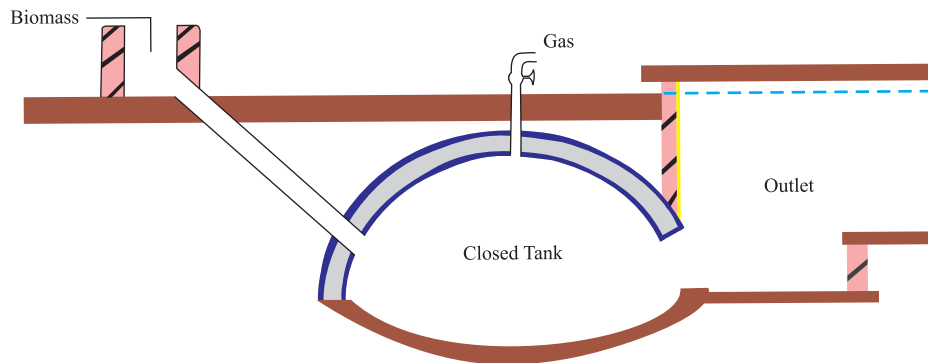

Fig. 7.15

The method of producing biogas from biomass is not complicated. Biomass is rotted in a closed tank or a pit. Bacteria helps to fermentate it and biogas is the output that can be piped out easily. The residue left over in the pit is a good fertilizer (Fig: 7.15)

Solid waste is the dry garbage that is collected by the municipality. Solid waste is burnt in a type of furnace. The heat thus produced is directly supplied to the boiler, which converts water into steam. The generators are run with this steam to produce electricity. This also solves the problem of solid waste disposal.

## 7.6 Measurement of Energy

Since energy is the ability to do work, therefore the unit of energy will be the same as that of work. The SI unit of work and energy is joule (J). This very unit is used for all kinds of energy.

### Measuring Electrical energy

Electrical energy can also be measured in joules. But practically kilowatt-hour unit is used for its measurement. The meters installed in our homes measure electricity in this unit. The number of units consumed by an electric appliance depends upon its power as well as the duration for which it is kept on.

**The energy consumed in one second is called power.**

$$\text{Power} = \frac{\text{Energy}}{\text{Time}}$$

The unit of power is watt. The symbol used for this is W. You might have read 60 W, 100W etc. printed over bulbs. This is the power of bulb. Power of the appliance is mostly printed on it. One thousand watt power is called as one kilowatt.

### Unit of electrical Energy

The unit of electrical energy is kilowatt-hour, which is denoted as kWh. The electricity meters measure electricity in this unit.

**One kilowatt-hour is the amount of energy that is consumed by a 1000 watt appliance in one hour.**

According to above definition of kWh a 100W bulb consumes one unit of electricity in 10 hours and a 200W bulb consumes in 5 hours. An air conditioner of 2500W consumes 2.5 units of electricity in one hour.

### Electricity Meter

An electricity meter is shown in (Fig. 7.16). The working principle of a meter is the same as that of electric motor.

Live wire of main supply passes through the field coils of the meter. At the centre of field coils there is another coil which can rotate about its axis. This coil is connected to the main supply through a high resistance. When an appliance in the home is turned on, current starts flowing through the field coils. This produces a magnetic field due to which the coil inside the field rotates. The disc rotating along with coil can be seen from outside. The larger the current flowing through the meter, the faster is the rotation of disc. The gears attached to the disc display meter reading on the dial in the form of

digits. Usually the digit to the extreme right is  $\frac{1}{10}$ th of the unit i.e., decimal point, while the reading to its left shows the number of units in kilowatt-hours.

### Measuring Natural Gas

Natural gas is measured in cubic metres. The gas turns a wheel while passing through its way. The gears attached to the wheel display the volume of gas on the dial (Fig. 7.17).

Although petrol, diesel and natural gas are measured in units of volume, but these fuels can also be measured in units of energy. For this, we should know the amount of heat produced in joules by a specific amount of fuel.

These days, gas bills are being charged on the base of Btu instead of cubic metres. The Btu is a unit of energy called the British Thermal Unit. One Btu is equal to 1055 joules.



Fig. 7.16 – Electricity Meter

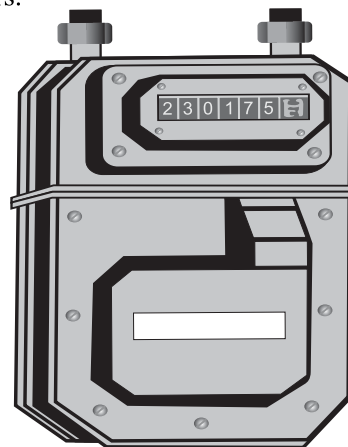

Fig. 7.17: Gas Meter

## 7.7 Energy and Environment

The living place of people and all physical and social factors around that affect their living and working conditions is called the environment. Air, water and land are the inanimate components of environment. Air is the main component of Earth environment. In the absence of air, no life could have been possible on Earth. Air is present up to the height of about

200 kilometres from the surface of Earth. It is called atmosphere. That part of atmosphere where all living bodies reside is 8 to 20 kilometres thick cover of gases over the earth. This cover acts as a shield against heat. Without this, the Earth would scorch with heat in the day and its temperature would fall to below  $0^{\circ}\text{C}$  in the night.

### Thermal Pollution

The unpleasant change occurring in air, water and surface of Earth that causes unhygienic effects on the human and animal life as well as on the plants is called pollution. Pollution is of many types, but we will discuss here the thermal pollution only.

**The pollution caused in the environment by heat, smoke harmful gases is called as thermal pollution.**



Fig. 7.18

Although heat is very essential for plants, animals and human life, but if the proportion of heat in the environment exceeds a certain limit, it could be harmful. The excessive use of energy has increased the thermal pollution in our environment. There are many factors that cause thermal pollution.

Carbon dioxide, carbon monoxide, sulphur dioxide, lead compounds and other harmful gases in addition to tremendous amount of heat are added in the atmosphere by the burning of fossil fuels. Fossil fuels are burnt in transport, in industries, for the production of thermal power and for many other purposes. The nuclear energy used for producing electricity is also a cause of addition in the thermal pollution. The cooling towers of



Fig. 7.19: Cooling Tower

nuclear reactors are adding heat into the atmosphere all the time. Other than this, all the forms of energy that we use are ultimately transformed into heat.

A big cause of increase in thermal pollution is the greenhouse effect. Carbon dioxide acts like glass of greenhouse. When the Earth after absorbing Sun heat, emits heat rays of larger wavelengths, carbon dioxide does not allow them to escape out into space but instead absorbs them. Therefore, the increase of carbon dioxide gas in the atmosphere causes increase in temperature at the surface of Earth. As the thermal pollution is increasing, the temperature of Earth's environment is also increasing.

## 7.8 Degradation of Environment

Normal thermal pollution does not affect the environment badly. Various natural processes such as plants, water etc. are always in action to keep the balance of environment. If thermal pollution is too much, the regional climate can be affected badly. The change of climate can also affect the whole system of agricultural production.

**When pollution more than a certain limit is added to the environment, it is known as degradation of the environment.**

In such an environment, not only the health of living bodies is damaged but also plants are affected. Harmful gases cause enhancement of eye, nose, ear and throat diseases.

### Steps to Minimize Environmental Degradation

The following steps can be useful to minimize thermal pollution.

1. The main role to minimize thermal pollution is played by forests. Plants absorb carbon dioxide from the atmosphere and emit oxygen. This helps to maintain balance of environment. But the growing population has started deforestation for their energy needs. This is depriving human beings of great blessing of God. It is needed that forestation be increased so that balance of environment may not be shattered.
2. The fitness of vehicles running on roads should be observed. Vehicles should not make smoke. Rickshaws particularly motorcycle rickshaws are producing too much pollution in cities. A better system of public transport can reduce pollution to much extent. If comfortable buses are available easily for public transport in cities, many people will stop driving their own cars and motorcycles. This will reduce pollution as well as save national money. Pollution will be minimized to much extent, if the trains has to run with electricity instead of fossil fuels. Electric trains network should be promoted in our country.

3. Industries consume almost 20% of energy resources. In addition to heat, poisonous gases emitted by them also cause pollution. Appropriate processing is needed for this.
4. Such energy sources should be promoted, which produce less pollution e.g., electric energy, solar energy, wind energy, tidal energy.
5. Excessive growth in population is also one reason of enhancement in pollution. As population increases, the need for energy also increases with the same ratio. Consumption of more energy means more increase in pollution. It suggests that population planning is very important.
6. People should be careful to burn solid waste and tyres etc. at public places.

## 7.9 Nuclear Fuel Hazards

The use of nuclear energy for production of electricity in advanced countries is increasing day by day. The possibility of leakage of the radiation during the use of nuclear energy cannot be denied. Radiation means the emission of alpha ( $\alpha$ ), beta ( $\beta$ ) and gamma ( $\gamma$ ) rays from some elements called the radioactive elements. The fuel of nuclear reactors is radioactive. The danger of radiation leakage is always there while storing, handling and using such fuel. The people who are working around reactors are always in danger.

Radiation has the capability to change the structure of cells, tissues and genes of living bodies by their impact with them. This can cause skin diseases and cancer. Even a small accident in a nuclear reactor could be very disastrous.



Fig. 7.20: The nuclear reactor of chornoble where the accident took place

In 1986, the cooling system of a reactor in Chornoble (Russia) failed, due to which roof of the reactor blew up with a blast in a few minutes and radioactive gas clouds spread all over the



area. Hundreds of people were killed in that accident. Later on many of the people died after suffering from cancer.

The used nuclear fuel does also emit some radiation. That is called nuclear waste. The disposal of nuclear waste is very necessary for safety against radiation. Different ways are adopted for this purpose. These methods include dumping of nuclear waste in the tunnels deep under the Earth and store it in sealed containers at the bottom of the sea. But no method is considered to be completely safe. One suggestion is that such material should be stored after fusing it into glass blocks. Another suggestion is that nuclear waste be filled in rockets and sent to the space or other planets or sent towards the Sun. But it is feared that rockets may explode in the Earth's atmosphere or they may come back to the Earth.

For protection from dangers of radiation, it is necessary that the workers should keep away from the radioactive source. Such sources should be kept in lead containers of thick walls, because lead does not allow radiation to pass through it. Thick concrete walls should be built around nuclear reactors and the nuclear waste should be disposed off very safely.

## 7.10 Conservation of Energy

The use of energy in factories, transport, offices, educational institutions and homes is so large that fuel reserves such as coal, oil and gas are exhausting very rapidly. Non-conventional resources of energy are still not out of research and development stage. Although efforts are made to use existing resources in a better way, but after all these resources are limited. In these circumstances, it is our national duty to consume energy carefully and promote alternative resources of energy. We can save much energy by acting upon the following suggestions:

- Substitute fuels should be used for transport. Many people are running their vehicles on CNG. Alcohol could be a good substitute fuel. Brazil has practiced it very successfully. Most of the vehicles run there with alcohol.
- People should be instigated to use public transport rather than driving their own vehicles. In this way many people can go to work in one big bus instead of going in many individual vehicles.
- The bodies of the vehicles should be made light so that they may consume less fuel.
- The engines with more efficiency should be designed for vehicles.
- A large amount of energy is wasted in the industries as heat. This heat can be used for different purposes.
- The need of energy in some industries can be fulfilled by burning different waste materials.



- We should be careful about unnecessary use of energy in offices schools and homes. Bulbs can be replaced by energy savers for light. We can use such electric appliances that consume less energy.
- We should develop the habit of walking for small distances.
- Biogas energy can be made available easily in villages free of any cost. Villagers should be instigated to make use of biogas.
- The small hydal power station should be constructed to fulfil the local needs of electricity.
- The use of non-conventional energy sources like solar energy, wind energy and tidal energy should be made practicable.

### IMPORTANT POINTS

- Work is the product of force and distance in the direction of force.
- Energy is the ability to do work.
- Energy possessed by a body due to its motion is known as kinetic energy.
- Energy possessed by a body due to its position is known as potential energy.
- The energy stored in a body by pressing, stretching or twisting is known as elastic energy.
- The energy which is emitted during the chemical reactions is called chemical energy.
- Energy of a body due to the movement of the molecules is called heat energy.
- When the electrons revolving around the nucleus jump from a higher energy orbit to a lower energy orbit, light is emitted.
- Electrical energy is the energy of moving charges.
- Energy is obtained by breaking the nuclei of heavy atoms. This process is called nuclear fission.
- The energy obtained in the process of nuclear fission is called nuclear energy.
- Conservation law of energy states that energy can neither be created nor destroyed.
- The conversion of the kinetic energy of running water to electrical energy is known as hydro-electric power.
- The production of electricity of burning coal, natural gas and oil is called thermal power.
- The production of electricity through the nuclear fission process is called nuclear power.
- The production of electricity from solar energy is called solar power.

- The production of electricity due to the kinetic energy of fast blowing air is called wind power.
- Tidal energy is the energy due to the tides of water. The production of electricity from tidal energy is called tidal power.
- To make use of energy deep under the Earth in the form of hot water or steam is known as geothermal.
- Organic materials and their residues are called biomass.
- The pollution caused in the environment by heat, smoke and harmful gases is called thermal pollution.
- When pollution more than a certain limit is added into an environment, it is known as degradation of the environment.
- The residue of the used nuclear fuel is called nuclear waste.

## GLOSSARY

<b>Work:</b>	Product of force and distance.
<b>Energy:</b>	Ability to do work.
<b>Kinetic Energy:</b>	Energy due to motion.
<b>Potential Energy:</b>	Energy due to position.
<b>Elastic Potential Energy:</b>	Energy stored due to pressing, stretching or twisting.
<b>Chemical Energy:</b>	Energy produced due to chemical reaction.
<b>Heat Energy:</b>	Energy due to molecular motion.
<b>Light Energy:</b>	Energy due to which we see things.
<b>Electrical Energy:</b>	Energy of moving charges.
<b>Nuclear Energy:</b>	Energy from the nucleus of atom.
<b>Hydroelectric Power:</b>	Production of electricity from flowing water.
<b>Thermal Power:</b>	Production of electricity from burning fossil fuels.
<b>Nuclear Power:</b>	Production of electricity from nuclear energy.
<b>Solar Power:</b>	Production of electricity from solar energy.
<b>Wind Power:</b>	Production of electricity from wind energy.
<b>Tidal Power:</b>	Production of electricity from force of water tides.
<b>Geothermal Power:</b>	Production of electricity by steam or hot water coming from depth of Earth.

<b>Biomass:</b>	Organic materials and their residues.
<b>Solid Waste:</b>	Garbage.
<b>Biogas:</b>	Gas produced by biomass.
<b>Kilowatt-hour:</b>	Unit of electrical energy.
<b>Environment:</b>	Living place of people including physical and social factors around them.
<b>Thermal Pollution:</b>	Addition of heat and harmful gases in the atmosphere.
<b>Greenhouse Effect:</b>	Increase in temperature of environment due to carbon dioxide gas.
<b>Degradation of Environment</b>	Addition of pollution in environment more than a certain limit.
<b>Nuclear Fuel:</b>	Materials, where from nuclear energy is obtained.
<b>Radiation:</b>	Alpha, beta and gamma rays.

## QUESTIONS

- Q. 1** Select the correct answer for the following statements:
- (i) The unit of energy is
    - (a) newton
    - (b) metre
    - (c) joule
    - (d) second.
  - (ii) The energy due to motion is called
    - (a) potential energy
    - (b) kinetic energy
    - (c) nuclear energy
    - (d) chemical energy.
  - (iii) The method of production of electricity that does not produce pollution is
    - (a) hydroelectric power
    - (b) thermal power
    - (c) nuclear power
    - (d) burning of biogas.
  - (iv) By burning fossil fuels, we get
    - (a) solar power
    - (b) tidal power
    - (c) nuclear power
    - (d) thermal power
  - (v) We can save energy
    - (a) by increasing personal vehicles
    - (b) by making vehicles of heavier bodies
    - (c) by not walking
    - (d) by avoiding unnecessary use of energy.

- Q. 2** Fill in the blanks:
- (i) Work is the product of force and distance travelled in the direction of \_\_\_\_\_.
  - (ii) We can see things with the help of \_\_\_\_\_.
  - (iii) Photocells convert light into \_\_\_\_\_.
  - (iv) The energy of the sea tides is called \_\_\_\_\_ energy.
  - (v) The safe disposal of \_\_\_\_\_ is very necessary to protect from radiation.
- Q. 3** Mark '✓' against true and '×' against false statement:
- (i) The energy possessed by a body due to position is called kinetic energy.
  - (ii) Electrical energy is the energy of flowing charges.
  - (iii) Chemical potential energy is stored in fossil fuels.
  - (iv) Cooling towers of nuclear reactors absorb heat from the atmosphere.
  - (v) When pollution less than a certain limit is added to the environment, it is known as degradation of environment.
- Q. 4** Give short answers to the following questions:
- (i) What is the law of conservation of energy?
  - (ii) Define the unit of electrical energy.
  - (iii) Define environment.
  - (iv) What is meant by degradation of environment?
  - (v) Write down the names of three conventional methods and five non-conventional methods of producing electricity.
  - (vi) Give any three suggestions for the conservation of energy.
  - (vii) Point out two suggestions for the safe disposal of nuclear waste.
- Q. 5** Define energy. What is the difference between kinetic and potential energy? Explain with the help of examples.
- Q. 6** Describe different forms of energy.
- Q. 7** What is meant by interconversion of energy? State law of conservation of energy.
- Q. 8** What are the conventional methods of producing electricity? Write a detailed note on any one of them.
- Q. 9** Describe any three non-conventional methods of producing electricity.
- Q. 10** In what unit is the electrical energy measured? Describe the principle and working of electricity meter.
- Q. 11** What is thermal pollution? How is it produced? How does it affect the environment?
- Q. 12** Write notes on the following:
- (i) Nuclear fuel hazards
  - (ii) Conservation of energy.

# 8 CURRENT ELECTRICITY

## In this chapter you will learn:

- Concept of Electric Current
- Conventional Current
- Potential Difference
- Ohm's Law
- Resistance
- Components of a Circuit
- Direct and Alternating Current
- Use of A.C. and D.C.
- Domestic Electric Supply
- Hazards of Electricity and Precautionary Measures
- Electrical Measuring Instruments
- Analogue and Digital Meters

Electricity is very common form of energy, which we use in our homes and work places everyday. It has facilitated the availability of our needs of life. Just turn on the switch and the electricity starts its work.

Electricity is used in four important ways. It causes fans, electric motors and machines to move. It provides light through bulbs, tubes and television. In a loud speaker it is converted into sound and in electric iron, heater and toaster it assumes the form of heat.

## 8.1 Electric Current

You know that electric current is the flow of charges. The charges are the free electrons, which are available in conductors. In some conductors like liquids and gases, the current also flows due to the motion of positive and negative ions. But a source of energy is required to force the charges into motion. The source pushes the charges through the circuit.

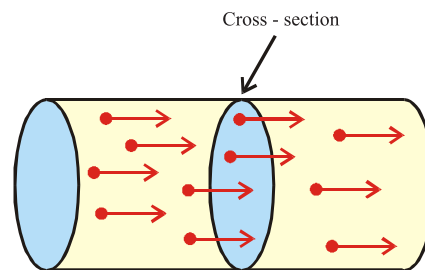

Fig: 8.1

**The amount of charge that passes through any cross-section in one second is called current.**

If charge  $Q$  passes through any cross-section in time  $t$  seconds then the current  $I$  can be written mathematically as

$$I = \frac{Q}{t} \quad \dots\dots\dots (8.1)$$

The unit of current in system International (SI) is ampere. It is denoted by A. Current can be measured by connecting an ammeter in series with the circuit.

**For your information**

$$1\text{mA} = 10^{-3}\text{ A}$$

$$1\mu\text{A} = 10^{-6}\text{ A}$$

**For your information**

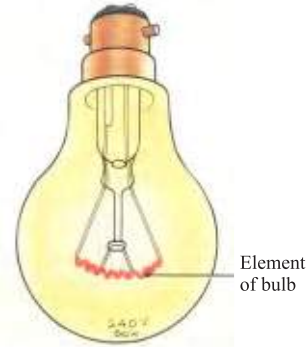

The element of bulb is wound tightly like a spring so that heat may not be wasted due to convection of air.

## 8.2 Conventional Current

From the very beginning after the discovery of electricity, it was assumed that the electric current is due to flow of positive charges, which move from positive terminal of the battery towards the negative terminal. This is called the conventional current. But, now, we know this fact very well that the charge carrying particles in metal conductors are the electrons having negative charge on them. Electrons move from negative terminal of the battery towards positive terminal. Thus in fact, the current is due to the flow of negative charges.

Keep in mind that electrons do not flow through a conductor like a stream but their motion is different. A number of free electrons are always bumping among the atoms of the conductor, which is called random motion (Fig: 8.2). In the absence of a battery, the number of electrons passing towards left is the same as through the right side. Thus net rate of electrons passing through any cross-section in one direction is zero.

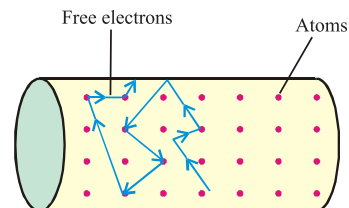

Fig. 8.2

When one end of a conductor is connected to the positive terminal of the battery and the other end connected to the negative terminal, the electrons experience force. Due to this force electrons start drifting towards the positive terminal of the battery in addition to their random



motion. As the electrons have negative charge, so they carry negative charge while moving through the circuit. However we can assume that

**The amount of positive charge flowing in one direction is equivalent to the same amount of charge flowing in opposite direction.**

Let us consider the following example to understand this.

Suppose that the body A carries  $+10C$  charge and the body B carries  $-10C$  charge. Let both of them be connected with each other through a wire for a small duration and then put them apart. If  $-4C$  charge is transferred from body B to A during this interval, then what should be the charge on bodies A and B after they are separated again.

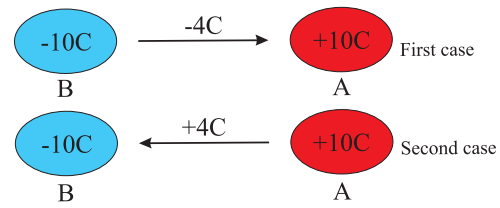

Fig. 8.3

In this case:

$$\text{Charge on body A} = +10C + (-4C) = +6C$$

$$\text{Charge on body B} = -10C - (-4C) = -6C$$

If we assume that  $+4C$  charge is transferred from body A to B, then

$$\text{Charge on body A} = +10C - (+4C) = +6C$$

$$\text{Charge on body B} = -10C + (+4C) = -6C$$

We see that in the both cases result remains the same.

In future, we will use the word “current” for “conventional current”. The words “electronic current” is used to indicate the direction of flow of electrons.

## 8.3 Potential Difference

When an electric circuit is completed by closing the switch, the negative terminal of the battery pushes the free electrons in the circuit towards positive terminal. This causes the flow of current.

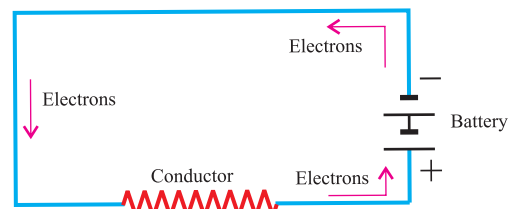

Fig. 8.4

The current flowing through a conductor can be considered analogous to the flow of water through the pipe. In Fig: (8.5), the water level is higher at position A and it is lower at position B. In this case the water will flow from position A to B. The water will stop flowing when level on both sides will be the same. Now, a pump has to be used to maintain the flow of water.

The pump will lift the water from B and will put it into the pipe at A. In this way the flow of water will continue. The water flows from A to B because the level of water at A is higher than that at B. A battery also acts like a pump. The chemical reaction in the battery transfers electrons from positive terminal to negative terminal. In this way the potential energy of the electrons, reaching the negative terminal, increases. This is the energy due to which electrons move towards the positive terminal in the outer circuit. The potential energy of the electrons decreases as they reach the positive terminal. The battery pushes them again towards the negative terminal. The energy required is provided by the chemical reaction in the battery.

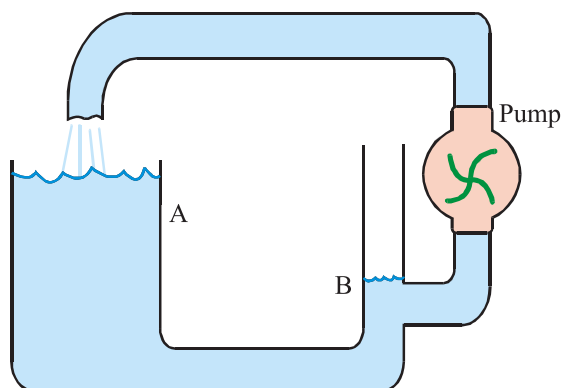

Fig. 8.5

If we refer to the conventional current, the current flows from positive to negative terminal. Therefore, like water the level of potential energy of the charge at positive terminal should be higher than that of potential energy at negative terminal. The level of potential energy is also called simply potential. Hence

**Current flows from higher potential towards lower potential.**

In order to maintain the current, charges gain energy from the battery and expend it while passing through the circuit. The capacity of supplying energy for different batteries is different. It depends upon the potential difference of the battery.

**The amount of energy supplied to one coulomb charge by a battery is called its potential difference.**

Potential difference is also called as voltage. The SI unit of potential difference is volt(V). The potential difference (V) between two points in a circuit can be measured by connecting a voltmeter parallel to the points.

## 8.4 Ohm's Law

Is there any relation between current and potential difference? Let us perform an experiment for this.

### Activity

Connect one metre long nichrome wire to a variable power supply as shown in Fig.(8.6). Also connect an ammeter in series with the circuit. Connect a voltmeter parallel to the nichrome wire. Increase the voltage step by step from the power supply. Keep on noting the

reading  $V$  of voltmeter and the reading  $I$  of ammeter. You will observe that the value  $\frac{V}{I}$  remains constant i.e.,  $V$  is proportional to  $I$ . The relation between potential difference and current, first discovered by George Simon Ohm in 1826 is that

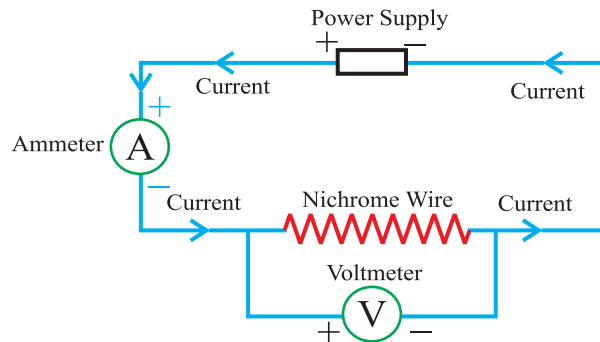

Fig. 8.6

**The current flowing through a conductor is directly proportional to the potential difference provided that the temperature and the physical state of the conductor does not change.**

This is called Ohm’s law. Mathematically, we can write it as:

$$\frac{V}{I} = R \quad \dots\dots\dots (8.2)$$

where  $R$  is a constant called the resistance of the conductor. From Ohm’s law, we can determine the value of any unknown quantity by knowing the other two quantities.

### 8.5 Resistance

The opposition to the flow of charges is called resistance. Resistance is equal to the ratio of potential difference and current. From equation 8.2

$$R = \frac{V}{I}$$

In a circuit diagram, resistance is shown by a zigzag line as shown in Fig. (8.7). The SI unit of resistance is ohm ( $\Omega$ ).



Fig. 8.7

**If one volt potential difference applied across the ends of a conductor gives rise to a current of one ampere, the resistance of the conductor is one ohm.**

The cause of resistance is that when a potential difference is provided across the ends of a conductor the free electrons in the conductor start moving from negative to positive end. In their way the free electrons collide with the atoms of the conductor due to which hindrance is produced in their motion. Because every conductor contains atoms in it, therefore every conductor does have resistance how so ever small it may be.

### 8.6 Components of a Circuit

Switches, resistors, capacitors etc. are inserted in a circuit in addition to the battery. These are

called the components of a circuit. Some important components are described below:

### Switches

A switch completes or breaks a circuit. When the switch is turned off, no current flows through the circuit. In the laboratory, the switch is replaced by a “key” which can be closed or opened. In the home, switches of different designs are used to turn electric appliances on or off. Some samples of switches and key are shown in Fig. (8.8).

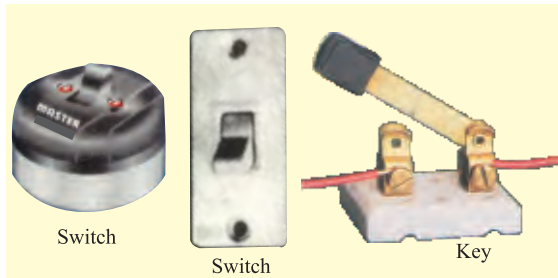

Fig. 8.8

### Resistors

The conductors having large resistance are called resistors. Bulb, heater, iron, fan and other electric appliances are all resistors. The charges flowing in a circuit carry energy from the battery and spend it while passing through the resistors. Here, the energy is converted into heat, light or motion.

When the electrons flowing through the circuit collide with the atoms, they transfer their energy to the atoms. With increased energy, the vibrations of the atoms become more vigorous and their temperature increases. That is why the resistors emit heat and light as we observe in case of lighted bulb or heater.

Resistors are also used to reduce or enhance the current in the circuits of appliances like radio, television etc. These are made from special materials. The values of resistance are indicated in the form of coloured bands on the resistors.

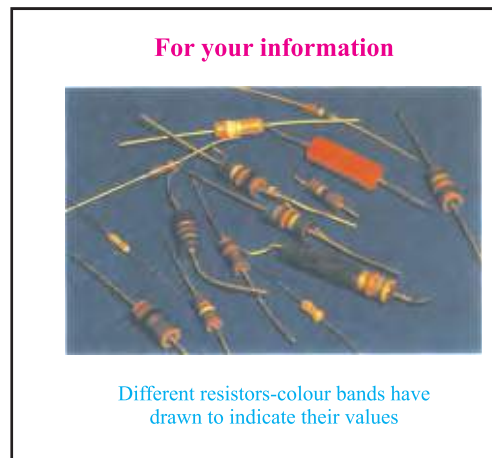

### Capacitors

Capacitors store electric charge and are used for many other purposes in electric circuits. A simple capacitor consists of two parallel metal plates. There is some insulator placed between the plates that is called the dielectric.

When the capacitor is connected across a battery, positive charge is deposited on one plate and negative charge is deposited on the other plate. The charges remain there even if the battery is removed. This is called charging of capacitors.

When the capacitor is charged, potential difference is developed across the plates due to the opposite charges. The more the charge is stored, the greater is the potential difference produced.

The SI unit of capacitance is farad (F). Farad is a bigger unit. Usually micro-farad( $\mu\text{F}$ ) is used as a small unit.

$$1\mu\text{F} = 10^{-6}\text{F}$$

### Types of Capacitors and Uses

Two long metal foils are usually used to enhance the area of plate of the capacitor. A layer of paper or plastic sheet is placed in between the plates and rolled up. This becomes a fixed capacitor.

Fixed capacitors are used in electric fans and motors. When the switch is turned on, the capacitor is charged. The current in the circuit increases as it discharges, and fan or motors start easily. Different types of capacitors are shown in Fig. 8.10.

Two sets of plates are used in a variable capacitor. One set is fixed whereas the other one can be rotated to change the area between the plates. This changes its capacitance. This is also called the gang capacitor. Such capacitors are used for tuning radio, television etc.

Capacitors are also used to smooth the ripples while changing A.C. into D.C. When a sound signal from microphone or tape recorder is fed to the amplifier, a capacitor is introduced in the way, so that the D.C. voltage of amplifier may not damage the microphone.

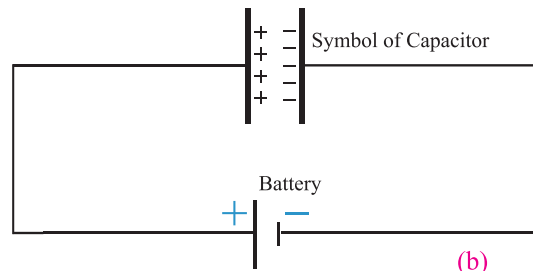
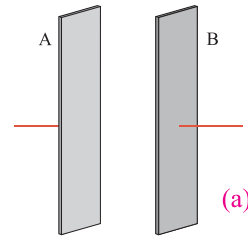
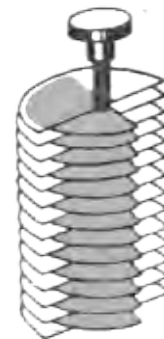
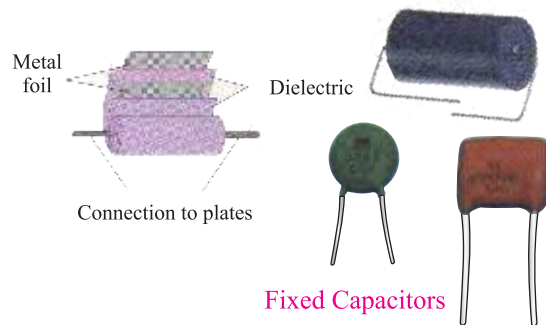

Fig: 8.9



Gang Capacitor  
Fig. 8.10

**Transformer**

Transformer is a device that decreases or increases the A.C. voltage. In A.C., current does not flow in one direction but it changes direction alternatively.

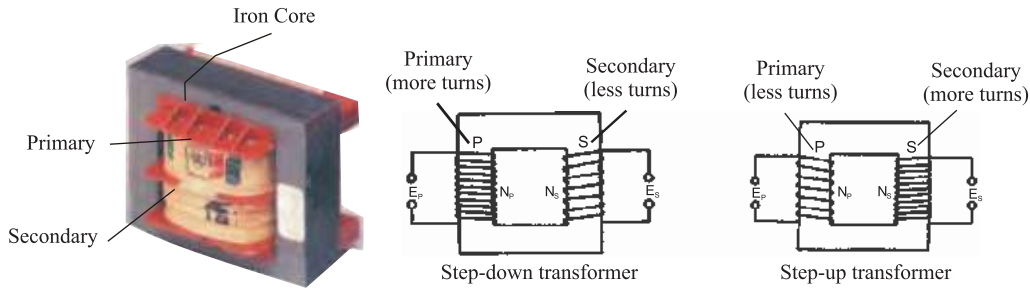

Fig. 8.11: Transformer

A transformer consists of two coils wound over an iron core. One coil is called the “primary” and the other one is called the “secondary”. When a current passes through the primary, a current is also produced in the secondary due to induction. The voltages in the primary and the secondary are proportional to their number of turns i.e.,

$$\frac{\text{Secondary voltage}}{\text{Primary voltage}} = \frac{\text{No. of turns in the secondary}}{\text{No. of turns in the primary}}$$

or  $\frac{V_s}{V_p} = \frac{N_s}{N_p} \dots\dots\dots (8.3)$

If the number of turns in the secondary are more than those of primary, it is called a step-up transformer. If the number of turns in the secondary are less than those of primary, it is called a step-down transformer. A step-up transformer increases the voltage whereas a step-down transformer decreases the voltage.

In a tape recorder, radio, computer etc. 220 volts are decreased to 6,9, or 12 volts with the help of a transformer and then provided to the appliances. In a television, the voltage is increased up to many thousands volts by using a step-up transformer.

Electricity is transmitted from power station to the cities at a very high voltage. This voltage is reduced to 220 volts with the help of transformers and then supplied to the consumers. If the electricity is transmitted from power station to cities at 220 volts, a large amount of energy would be lost.

**8.7 Direct and Alternating Current**

When both ends of a conductor are connected to the battery, current starts flowing through it. The current is directed from positive to negative terminal (Fig. 8.12).

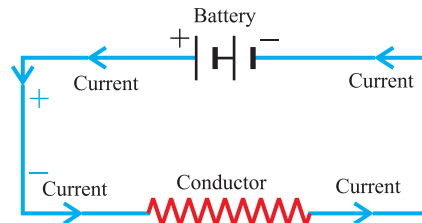

Fig. 8.12



**That current which always flows in one direction is called the direct current.**

Commonly, the direct current is termed as D.C. There is another type of current, which changes its direction again and again.

**The current which changes its direction again and again is known as alternating current.**

The alternating current is abbreviated as A.C. The electricity supplied to our homes is also A.C.

## 8.8 Uses of D.C. and A.C.

Cells are used in torches, watches and toys. These are the sources of direct current. A car battery also provides D.C. Actually radio, tape recorder, television and computer etc. all work with D.C. These appliances use A.C. supply after converting it into D.C. Electric fans, motors, bulbs and heaters etc. work with A.C.

Electricity supply is brought from far off places through cables. If it were transmitted at 220 volts, a major portion would have been wasted. Therefore, electricity is transmitted from the power stations at a very high voltage. Then voltage is reduced locally to 220 volts with the help of transformers and supplied to the consumers. As the transformer can change only the A.C. voltage and not the D.C. voltage, therefore A.C. is preferred to D.C. Besides this, A.C. can be converted into D.C. very easily whenever needed as in case of electroplating. Moreover, A.C. is used for carrying signals of microphone, tape recorder and for the radio, television transmissions.

## 8.9 Domestic Electric Supply

A.C. electric supply of 220 volts is provided at our homes. A domestic circuit is shown in (Fig. 8.13). Two wires enter our home from the meter. One wire is called live or hot and the other is called neutral or cold. Electric energy is supplied to our homes through live wire. Neutral wire is the return path for the current so that the circuit can be completed. The electric potential of neutral wire is zero. There is always a potential difference of 220 volts between the live and the neutral wire. A third earth wire is also shown in the circuit. This is used for protection. You have already studied the use of earth wire in the previous classes.

### Circuit Wiring

First of all a switch is introduced in the way of both live and neutral wires in the domestic circuit. This is called the main switch. It turns the whole circuit on or off. Following the main switch there is a fuse box where the main electric supply is divided into many parallel circuits. In this way all the electric appliances are provided with the same potential difference of 220 volts. These parallel circuits carry currents to the lights, heaters and other appliances. Every parallel circuit contains a live wire, a neutral wire and an earth wire.

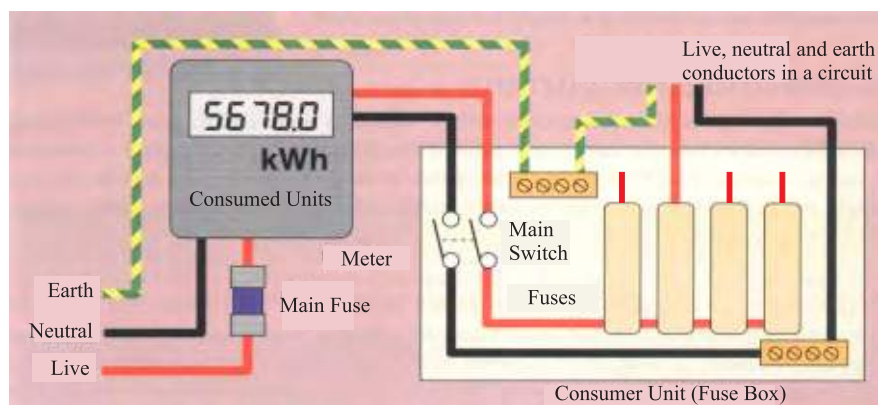

Fig. 8.13

### Fuses and Switches

Fuse is such a device which does not allow current to pass through it over a certain limit. If the current exceeds the limit, the fuse wire melts and we say that fuse has blown. Fuses are of different values. A fuse is introduced in the path of live wire in every parallel circuit. A fuse used in a circuit is of slightly higher value than the current required to be passed through the circuit. Usually a 13 ampere fuse is used for the power plug and a 5 ampere fuse is used for the lights. Now a days circuit breakers are replacing the fuses. These are turned off automatically on passing more or less current than its limit. In Fig. 8.14, fuses of different types are shown.

All the electric appliances are connected in parallel with the main supply. A separate switch is used for each appliance to turn it ON or OFF. Switches are introduced in the ways of live wires only. If they are introduced in the way of neutral wires, the fan, heater etc. will remain “live” even if the switches are OFF. Thus danger of electric shock by touching the appliances will remain there.

### 8.10 Measurement of Electricity Supply

You receive electricity bill at your home every month. The amount of electrical energy consumed during the month and its price is printed on the bill. The unit of electrical energy is kilowatt-hour. You have read about this unit in the previous chapter. The electricity meters installed in our homes measure the electricity in the same unit.



Fig. 8.14: Fuses of Different Types



Circuit Breaker

If you want to know how much electricity have you consumed in a certain period, follow the procedure given below.

- i. Note the reading of your meter in the beginning of the said period.
- ii. At the end of that period, note the reading again.
- iii. The difference of both the readings is equal to the amount of electrical energy consumed.
- iv. The total price can be calculated by multiplying the consumed energy with the rate of units of electricity.

## 8.11 Dangers of Electricity and Precautionary Measures

There are many advantages of electricity. But you cannot deny its danger as well. A few of them are described below.

### Electric Shock

Sometimes live wire may touch with the metallic body of electric appliance like fan or iron. If a person in this state happens to touch that appliance, a current starts flowing through him into the ground.

**When a current flows through a living body, it is called an electric shock.**

Some part of the body may burn with the electric shock or even death can be caused.

### Fire

Electric appliances are the resistors. The current flows through them up to a certain limit. If the insulation of wire is damaged due to some reason and the wires touch together, the current completes its circuit through wires only without passing through the resistor. As the wires have negligible resistance, so a large current starts flowing through them. The wires become so hot that these catch fire.

This fire becomes more dangerous after it spreads away.



Fig. 8.15



Overloading



Damaged Insulation

Fig. 8.16

Besides damaged insulation, overloading or damp conditions could also be the cause of fire (Fig. 8.16).

### Explosion

At the places where petrol, diesel, fireworks or other inflammable chemicals are present, the short circuiting become extremely dangerous. These materials can explode after catching fire. The chances of explosion increase many times in a military ammunition depot.

### Precautionary Measures

Dangers of electricity can be controlled by making precautionary measures. Here below are given some precautionary measures. By taking these measures, dangers can be avoided to much extent.

1. Always insert switches in the way of live wire.
2. Do not plug in many electric appliances in the same socket. It will cause overloading.
3. Do not let electric appliances touch with water. As water is conductor of electricity, therefore, it may increase the chances of short circuiting.
4. The use of fuses and circuit breakers reduce the dangers of electricity.
5. Earth wire must be connected to the electric appliances. This can save from possible accidents.
6. Do not pull the wire removing out a plug from the socket. Always pull out the plug.
7. Fire extinguishers should be made available in offices and factories for the emergency use.

### First Aid Administration

1. If a person has received electric shock, watch before touching him whether he is not still in contact with the electric appliance. If so, turn off the main switch immediately. In case the main switch is out of reach, detach the affected person from the appliance with the help of a wooden rod or a plastic object.
2. The electric shock can stop respiration and it can also cause death of the victim. If breathing stops, try to restore respiration artificially by giving air through mouth.
3. In case the heart stops beating, press upon the chest repeatedly with both of your hands. It may restore heart beating.
4. Immediately call for the ambulance and carry the patient to the hospital.

## 8.12 Measuring Instruments

Different instruments are used for the measurement of current, voltage and resistance. Basically, galvanometer is an instrument which detects the current. Different measuring instruments are made by making modification in the galvanometer.

You have learnt about electric motor in the lower classes. The principle of the galvanometer is the same as that of an electric motor. A coil of wire is placed between the opposite magnetic poles. An axil passes through the centre of the coil. When current is passed through the coil, it turns about the axil. The springs at the ends of the axil are tightened as the coil rotates. They stop further rotation of the coil.

As the coil rotates, a pointer fixed on the coil also deflects along a circular scale (Fig. 8.17). The more the current the larger is the deflection. A galvanometer attains full scale deflection only with a few milliamper current. That is why a galvanometer is not used to measure the exact amount of current, but it is used only to detect the current.



Fig. 8.17 (a)  
Galvanometer

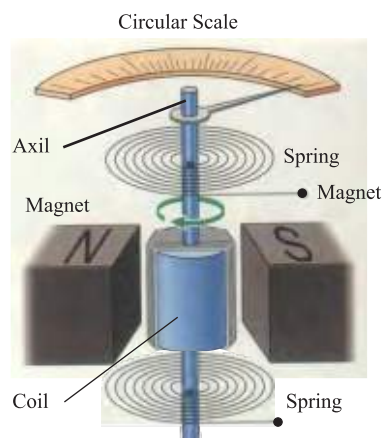

Fig: 8.17 (b)



## Ammeter

Ammeter is an instrument which measures the current. This is made by connecting a small resistance in parallel to the coil of the galvanometer. This resistance is called the “shunt”. The major portion of the current passes through the shunt. Only a small portion passes through the galvanometer. The value of the shunt resistance is determined by the desired range of the ammeter (Fig. 8.18).

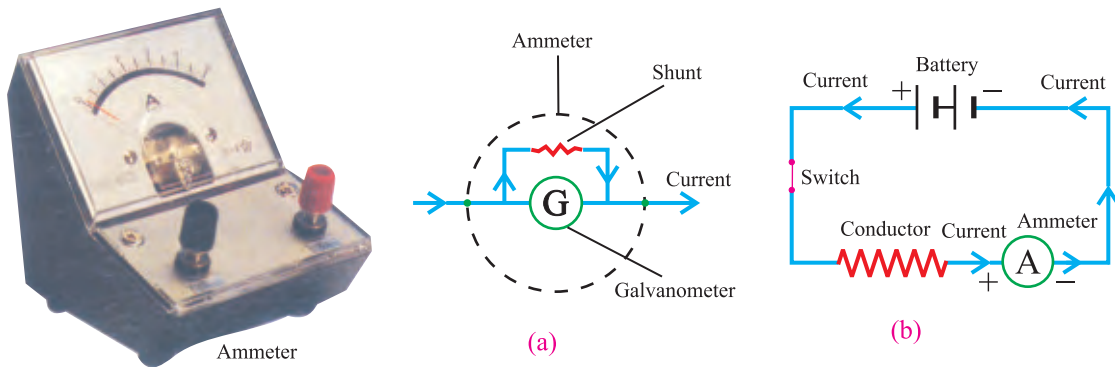

Fig. 8.18: Ammeter

Ammeter is always connected in series with a circuit. So that all the current to be measured should pass through the ammeter. Due to this reason the resistance of the ammeter is very low, so that it may not alter the current in the circuit. While connecting the ammeter in a circuit, care should be taken that the current may not exceed its range. Moreover the current should enter an ammeter from its positive terminal.

## Voltmeter

Voltmeter is an instrument which is used to measure potential difference. This can also made by modification in the galvanometer. A high resistance is connected in series with the coil of the galvanometer. This converts it into a voltmeter (Fig. 8.19). The value of high resistance depends upon the range of the voltmeter. Usually this resistance is of many thousands ohms.

A voltmeter is connected in parallel to the points across which the potential difference is to be measured. As the resistance of a voltmeter is very high, so it does not draw any current from the main circuit. By using the voltmeter in this way, the potential difference between the two points does not change and it is measured accurately. Like ammeter, care must be taken in the use of voltmeter. Its positive terminal should be connected to that point whose potential is higher than the other.



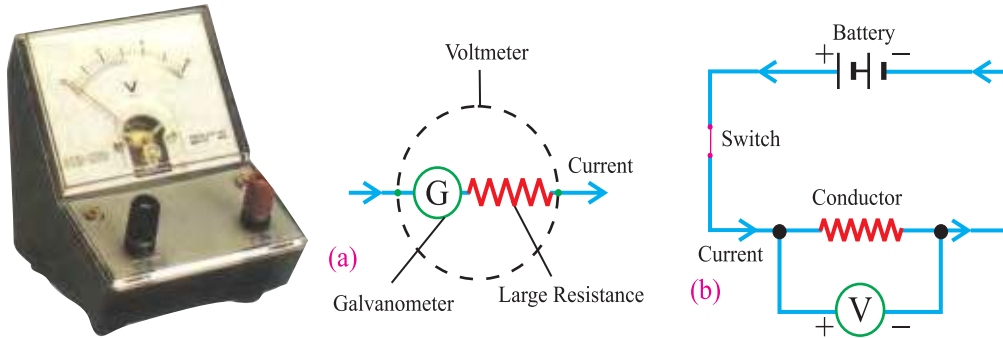

Fig. 8.19: Voltmeter

### Multi-meter

This is an instrument which can be used to measure current, potential difference and resistance. This is also called AVO meter. Here “A” stands for ampere, “V” for volt and “O” for ohm.

Multi-meter is also a galvanometer which is converted into ammeter, voltmeter and ohmmeter by necessary modifications. For any one measurement its function is selected with the help of a switch. Ranges can also be selected for every function. For use as voltmeter, it is provided with the facility to measure both D.C. and A.C. voltages (Fig. 8.20).



Fig. 8.20 Multimeter

### 8.13 Analogue and Digital Meters

The meters about which you have read so far are such that you have to note the position of a pointer on the circular scale to take the reading. As the scale is continuous, so every reading is possible in the scale. Such meters are called analogue meters. A meter shown in (Fig. 8.20) is an analogue meter.

There is also an electronic meter for measuring current potential difference and resistance. That is called the digital meter. It also performs all the functions of an AVO meter. But the difference is that in a digital multi-meter, the reading is displayed in the form of digits that can be read easily. Error is possible by the human eye while looking at the position of the pointer on the scale of an analogue meter. On the other hand, this error is not possible in the digital meter because of its display in digits.



Fig. 8.21: Digital-meter

## IMPORTANT POINTS

- Amount of charge that passes through any cross-section in one second is called the electric current.
  - The unit of current in system international is ampere.
  - Amount of negative charge flowing in one direction is equivalent to the same amount of positive charge flowing in opposite direction.
  - Current flows from higher potential to lower potential.
  - Amount of charge supplied to one coulomb by a battery is called its potential difference.
- Ohm's law is that the current flowing through a conductor is directly proportional to the potential difference, provided that the temperature and the physical state of the conductor does not change.
- The opposition to the flow of charge is called resistance.
  - Transformer is a device that is used to decrease or increase the A.C. Voltage.
  - If the number of turns in the secondary are more than those of primary, it is called a step up transformer.
  - If the number of turns in the secondary are less than those of primary, it is called a step down transformer.
  - The current which flows in one direction only is known as direct current.
  - The current which changes its direction again and again is known as alternating current.
  - All electric appliances are connected in parallel with the main electric supply.
  - The unit of electrical energy is kilowatt-hour.
  - When a current passes through a living body, it is an electric shock.
  - Galvanometer is used only to detect the current.
  - Ammeter is an instrument that measures the current. It is always connected in series with the circuit.
  - Voltmeter is an instrument that measures the potential difference. Voltmeter is connected in parallel with those two points across which the potential difference is to be measured.
  - Multimeter is an instrument that is used to measure current, potential difference and resistance.
  - The instrument that shows continuously decreasing or increasing readings is known as analogue, and the instrument that shows only discrete readings is known as digital.

## GLOSSARY

**Electric Current:** Amount of charge passing through any cross-section in one second.

<b>Conventional Current:</b>	Flow of positive charge.
<b>Potential Difference:</b>	Energy consumed by one coulomb charge.
<b>Resistance:</b>	Opposition of the flow of charges.
<b>Resistors:</b>	Conductors of large resistance.
<b>Capacitors:</b>	Device that stores charge.
<b>Transformer:</b>	Device that increases or decreases A.C. voltage.
<b>Direct Current:</b>	Current that flows in one direction only.
<b>Alternating Current:</b>	Current that changes direction again and again.
<b>Switch:</b>	Device that completes or breaks a circuit.
<b>Kilowatt-hour:</b>	Unit of electrical energy.
<b>Electric Shock:</b>	Flow of current through a living body.
<b>Ammeter:</b>	Instrument for measuring current.
<b>Voltmeter:</b>	Instrument for measuring voltage.
<b>Multimeter:</b>	Instrument for measuring current, voltage and resistance.
<b>Analogue Meter:</b>	Instrument showing continuous reading with the help of pointer.
<b>Digital Meter:</b>	Instrument displaying reading in digits.
<b>Induction:</b>	Appearance of current due to relative motion of magnet and coil.

## QUESTIONS

- Q.1** Put “√” against true and “×” against false statement.
- (i) Amount of charge passing through any cross-section in one second is called electric current.
  - (ii) The unit of electric current is volt.
  - (iii) Current flows from higher potential to lower potential.
  - (iv) Switches should always be placed in the way of live wire.
  - (v) D.C. voltage can be decreased or increased with the help of a transformer.
- Q.2** Fill in the blanks.
- (i) The current flowing through a conductor can be considered analogous to water flowing through a \_\_\_\_\_.
  - (ii) Potential difference is also called \_\_\_\_\_.
  - (iii) The \_\_\_\_\_ to the flow of charges is called resistance.
  - (iv) The charge on a capacitor is proportional to \_\_\_\_\_.
  - (v) Ammeter is always connected in \_\_\_\_\_ with the circuit.

- Q.3** Four possible answers are given for each statement. Select the correct answer.
- (i) The instrument that measures current is called  
(a) voltmeter (b) circuit breaker (c) ammeter (d) switch
  - (ii) The potential of the neutral wire is  
(a) zero (b) +220Volts (c) 220Volts (d) changing
  - (iii) The SI unit of resistance is  
(a) ampere (b) volt (c) hertz (d) ohm
  - (iv) The constant in Ohm's law is  
(a) current (b) resistance (c) potential difference (d) charge
  - (v) The device used for turning a circuit ON or OFF is:  
(a) switch (b) fuse (c) circuit breaker (d) earthwire
- Q.4** Write short answers of the following questions:
- (i) What is an electric current?
  - (ii) Define potential difference.
  - (iii) Which quantities does Ohm's law relate?
  - (iv) Define resistance.
  - (v) What are resistors?
  - (vi) What is meant by charging of a capacitor?
  - (vii) Where are the gang capacitors used?
  - (viii) What does a step-up transformer do?
  - (ix) What does a step-down transformer do?
  - (x) Where is a shunt resistance connected to convert a galvanometer into ammeter?
- Q.5** Define electric current. What is conventional current? Explain.
- Q.6** Explain potential difference with example. Define its unit.
- Q.7** What is resistance? Define the unit of resistance.
- Q.8** What is a capacitor? Give some uses of capacitors.
- Q.9** What is the difference between direct current and alternating current? explain.
- Q.10** How does structure of a voltmeter differ from that of an ammeter? Describe the use of both of them.
- Q.11** What is multi-meter? What is it used for? Describe the difference in analogue and digital meter.

## 9

## BASIC ELECTRONICS

In this chapter you will learn:

- Semi-conductors
- Semi-conductor Diode
- Radiowaves
- Radio System
- Television
- Satellite T.V.
- Computer
- Analogue / Digital Converters
- Telecommunication
- Communication System

Revolutionary changes have occurred in the world during the last fifty years. Specially, there has been much progress in the field of electronics. Early radio set was so big that two persons could hardly move it . People used to have huge gramophones to enjoy music. Conquest of space was confined to only imagination. In the beginning, big valves were used in the T.V. set. Computer occupied many rooms.

But today is the age of microchips. By the use of chips, T.V. and computers are reduced in size to such extent that they can be easily shifted from one place to another. Their efficiency has increased to many folds. Communication through satellites has become very common. Transmission from any place can be watched all over the world. This is all by virtue of electronics.

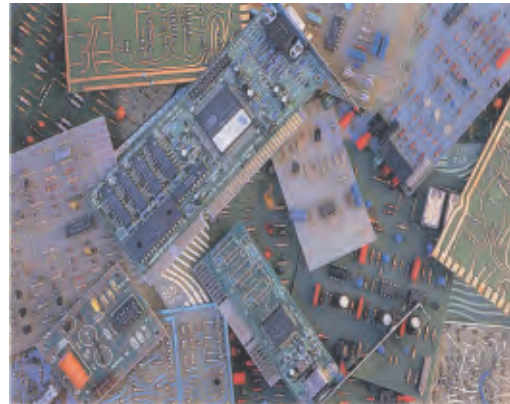

Electronic Components

**Electronics is the knowledge of behaviour and control of electric current.**

Electronics uses the electric current to convert information into signals. These signals could be of sound, picture, number or other informations.

## 9.1 Semi-conductors

Electronic devices are used to control the electric current. Modern electronic devices mostly consist of semi-conductors. The major function of electronic devices is to amplify the weak electric signals.

Semi-conductor is such a substance which has the ability to conduct current in between conductors and insulators. Silicon and germanium are two common semi-conductors which belong to the fourth group of periodic table. In Fig. (9.1) a pure silicon crystal is shown.

In pure semi-conductors, no free electrons are available to conduct electric current at very low temperature but at ordinary temperature, some of the electrons get free. This makes it possible to conduct some current through the semi-conductor.

Semi-conductors are made more useful by increasing their conductivity. This is done by adding some quantity of trivalent or pentavalent atoms as impurity while growing the crystals of silicon or germanium. This process is called doping. This addition is usually done in the ratio of one to  $10^8$  atoms.

### N-type Semi-conductor

When a pentavalent impurity such as arsenic (As) is added to silicon crystals, then due to this process the number of free electrons in the semi-conductor increases (Fig. 9.2). Such a material is called as N-type semi-conductor. Most of the current flow through N-type semi-conductors is due to free electrons.

### P-type Semi-conductor

If a trivalent impurity such as aluminium (Al) is doped in silicon crystal, then there is a deficiency of an electron in the outermost orbit of silicon atom. This deficiency of electron is called a hole (Fig. 9.3).

Thus this type of doping increases the number of holes in the semi-conductor. Such material is known as P-type semi-conductor. The current flow through it is mostly due to the holes.

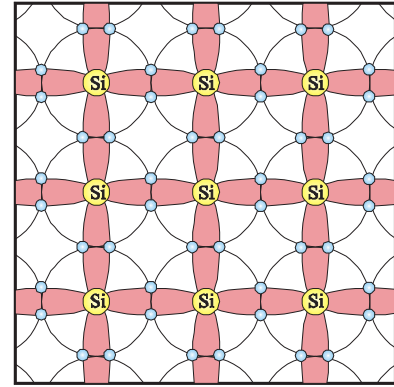

Fig. 9.1

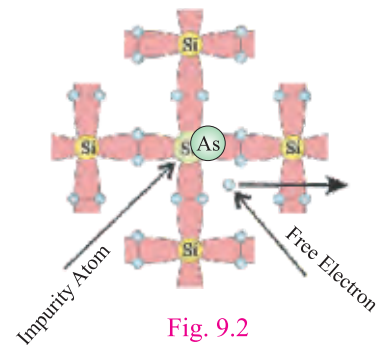

Fig. 9.2

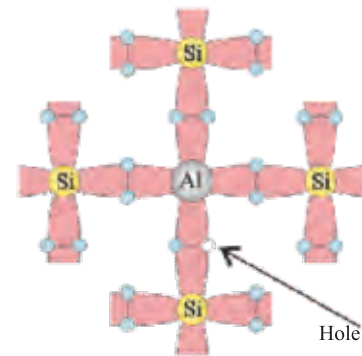

Fig. 9.3



### Semi-conductor Diode

If the silicon crystal is doped in such a way that its one end becomes N-type and the other P-type then it is called a P-N junction diode or semi-conductor diode. The P part of diode is known as anode and N part as cathode (Fig. (9.4).

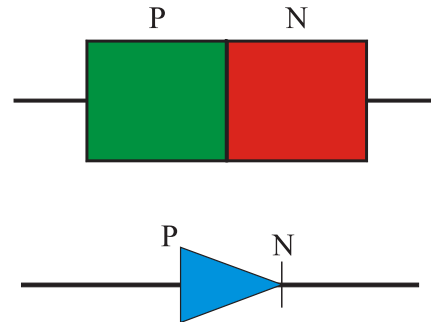

Fig. 9.4: Semi-conductor Diode

### Forward Biased Diode

The symbol of diode is shown in (Fig. 9.4). When the anode of a diode is connected to the positive terminal of the battery and the cathode to the negative terminal, the current starts flowing through the diode from p-type to n-type of the junction. This is known as forward biased diode.

### Reverse Biased Diode

When the anode of a diode is connected to the negative terminal of the battery and the cathode to the positive terminal, it is known as reverse biased diode. In this mode, the current flowing through the diode is almost zero.

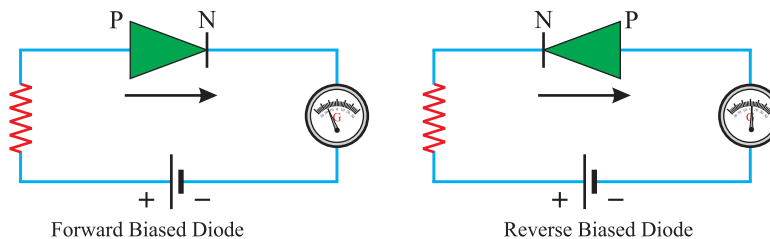

Fig. 9.5

## 9.2 Use of semi-conductor diode

There are many uses of semi-conductor diode. Some of them are given below:

### Rectifier

The electricity supplied to the consumers is an A.C. But many appliances such as radio, T.V. and computer etc. work with D.C. voltage. Therefore, A.C. is to be converted to D.C. to run such appliances.

Process of converting alternating current to direct current is called rectification. The device,

which is used to convert A.C. is known as rectifier. A semi-conductor diode is also used as rectifier.

## (ii) Light Emitting Diode

Light emitting diodes are made from specific compounds of gallium. It is forward biased. There is such a potential barrier in it at the P-N junction that when an electron occupies the hole after entering into P region from N, light is emitted. Such types of diodes are available in red, green, blue, yellow and white colours. These are also used as indicator lamps. Now a days these diodes are also used in the audio deck to display ups and downs in the loudness of sound.

Another important use of LEDs involve the display of seven segment digit in the digital clock, cash register and calculator. The English digit 8 has been divided into 7 segments as shown in Fig. (9.6).

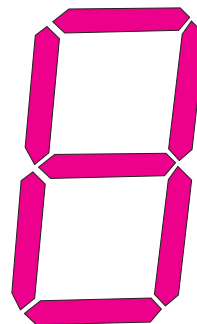

Fig. 9.6: Segment display be LED's

## (iii) Photodiode

These are the diodes which are sensitive to light. Such diodes are used in the mode of reverse biased. When no light falls on them, their resistance is very high (in mega ohm). Its resistance goes on decreasing as the light falling on it increases. In this way the reverse current also increases with the increase of incident light. These diodes are used for detection of light and in the computer and video games etc. These are also used as automatic switches in the circuits.

## 9.3 Radiowaves

You know that sound reaches our ears in the form of waves. These waves require certain medium for their propagation. On the other hand light is also a form of waves, but it does not require any medium for its propagation. Light can pass through vacuum as well. Such waves are known as electromagnetic waves. Heat, light, x-rays etc., are all electromagnetic waves. These differ only in frequency. Radio waves are also electromagnetic waves.

Their frequency ranges between 10 Hz and  $10^8$  Hz and their speed is that of light. Radio waves are also called carrier waves, because these are used to carry radio and T.V. transmissions

For your information



Marconi was the inventor of radio system

from one place to another.

## Radio System

Sound waves cannot travel through long distances. Moreover their speed is very low, that is about 340 metre per second. To carry sound waves to long distance, radio waves are used. For this purpose radio stations are built.

At a radio station, microphone converts sound into electric signal. An electric circuit produces radio waves of some particular frequency. These are then mixed with sound signal. These carrier waves are transmitted all around through a transmitter antenna.

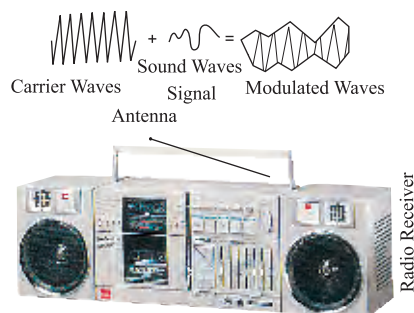

Fig. 9.7

The carriers waves of up to 30 kHz are used for radio transmission. Different radio stations use carrier waves of different frequencies. Our radio set is a receiver. By its tuning, any desired frequency can be selected. A radio set receives the carrier waves of that particular frequency through its antenna for which it has been tuned. The receiver separates the sound signals from carrier waves. In the end, the receiver amplifies sound signals and send them to the speaker, which converts it again to sound.

## Television

The transmission of television also reaches far off places through carrier waves like radio. Video camera converts picture and microphone converts sound into electric signal. These signals are called video and audio signals respectively. At the T.V. station, carrier waves are mixed with these signals and transmitted in air through transmitter antenna.

When these waves strike T.V. antenna, a slight alternating current of the same frequency is produced in it. The circuits of T.V. separates audio and video signals from each other. These signals are then amplified. Audio signal goes to the speaker which converts it into sound. Video signal goes to the picture tube.

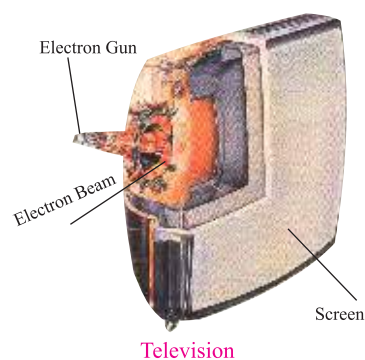

In the picture tube, an electron gun throws beam of electrons on the screen. The beam scans the screen just as you are reading every line of this page. A fluorescent material is coated on the inside of screen. When electrons fall on it, light is emitted. The beam of electrons produces bright dots on the screen according to video signal. Bright and dark parts compose the picture. About 25 pictures are completed on the screen in one second. That is why the picture looks moving. In a

colour television there are three electron guns, which form red, green and blue pictures at a time on the screen. These three colours blend into a colourful picture.

### Cable T.V

In cable T.V. electrical signals are not converted into radio waves, but these reach a T.V. set from T.V. station through cables. The companies providing cable connections also receive programme from satellites and thereafter transmit them to their consumers. High quality picture and sound is received through cable.



Cable T.V.

### Satellite T.V

The range of a 100 meters high T.V. transmitter aerial is about 30 kilometers. For inland transmissions, boosters or repeaters are installed at suitable distances. They transmit signals onward through microwaves after reinforcing them. However transmission cannot be carried to far away countries by this method. The reason is that our Earth is a sphere and the microwaves travel in a straight line. Describing a long distance they go much above the surface of Earth.

To send waves to the other side of the Earth, they are transmitted via satellites. Satellites are orbiting the Earth. Such satellites which seem to be stationary at some particular positions, are called as hovering satellites. Their orbits are known as geostationary orbits. A satellite orbiting at a distance of about 36000 kilometres above the equator completes its rotation in 24 hours. In the same interval, the Earth also completes its rotation about its axis. In this way this satellite seems to be stationary at the same position. Microwaves are used to send signals to the satellite from a ground station (Fig. 9.8).



Repeater

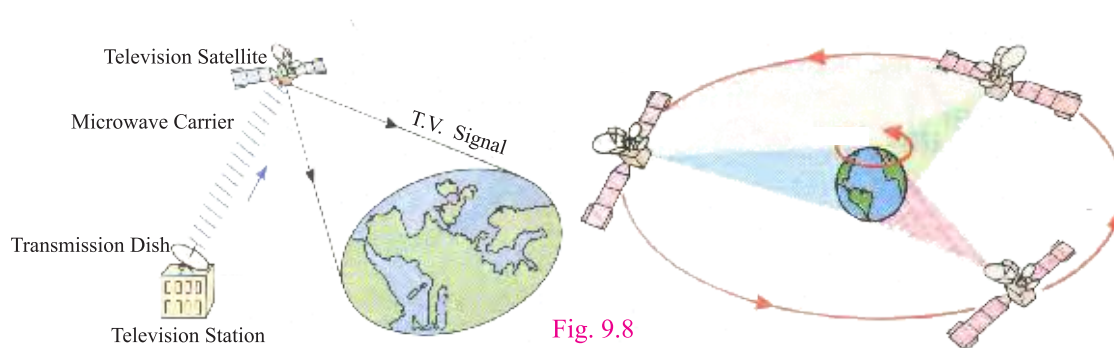

Fig. 9.8

On the ground, these transmission can be watched by receiving signals through dish antenna. Three hovering satellites can send transmissions to all over the world.

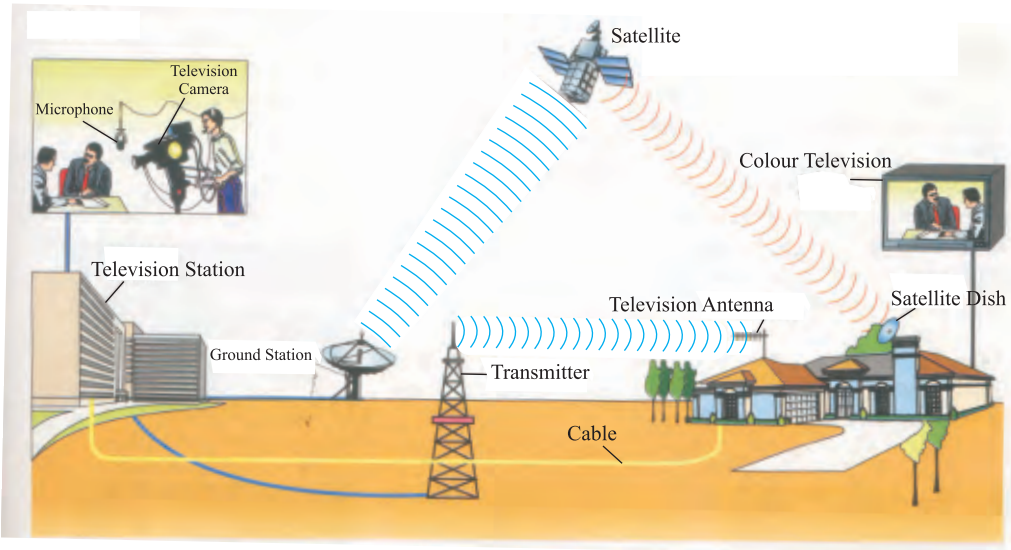

Fig. 9.9

In Fig. (9.9) T.V. Transmissions through radiowaves, cable and satellite are shown.

## 9.4 Computer

This is the computer age. Hardly a literate person could be unaware of the computer. In the homes, we use washing machine, microwave oven, satellite receiver, sewing machine and other electronic devices, which are all, being computerized. When you buy something from a big store the salesman on the counter just scans its bar code by laser light and all details including price etc. appear on the computer. Banks and other commercial institutes have computerized all of their business. Computerized machines are being used in the medical fields. Computers are controlling road traffic and air traffic. Electricity, water and gas supplying departments are keeping all their records on computers. Preparation of bills and receipts of money are made through computers. Before this, most of the people used to send letters for correspondence, but recently the use of E-mail has become very popular. Revolutionary



Computer



changes have been brought in the field of publishing, printing and graphics. Even the paintings are made on computers. Robots are assembling cars. Computerized machines are being used in industries. Computer games have changed the complexion of games. In short, the computer has brought revolution to our lives. The computer has made the world so small that people are calling it the global village. Let us know what is a computer?

**Computer is an electronic machine that receives raw data and processes it into useful information under the given instructions.**

Useful information includes rearrangement, analysis, explanation and arithmetic and logic solution. Apparently computers are very complicated but they are very simple as regards their functions and results.

A computer can be basically divided into two parts:

1. Hardware
2. Software

### 1. Hardware

The components of computer that can be physically touched are called the hardware. For example key board, mouse, printer and monitor etc. There are four main parts of hardware.

- i. Input devices
- ii. Central processing Unit
- iii. Output devices
- iv. Information storage devices

#### i. Input Devices

The devices through which data is entered in the computer are known as input devices. The most common input device is the keyboard (Fig. 9.10). It is similar to a typewriter. Instructions to the computer are typed by keyboard. There are some functional keys on the keyboard, which serve different purposes.

There is another device commonly used in place of functional keys known as mouse (Fig. 9.11). This is also an input device, which is rolled over a pad. This makes the input easier and faster. Floppy disk and compact disk are also input devices. These will be discussed later. Scanner is another

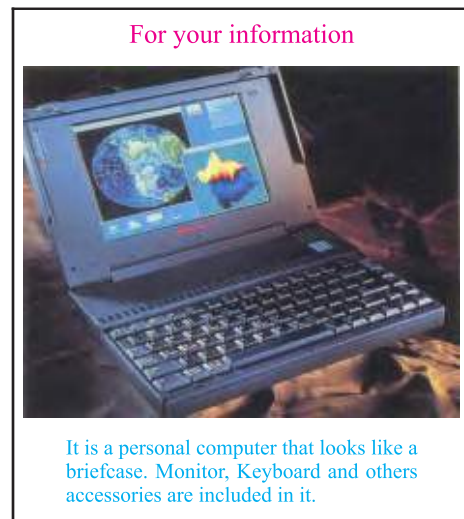

Fig. 9.10: Keyboard



Fig. 9.11 : Mouse



important input device through which pictures and documents can be fed to the computer in their original form. This has facilitated much in the field of publishing. Laser pen is also used to enter data in the computer.

Input devices feed data to central part of the computer called CPU where data is processed.

## ii. Central Processing Unit

The brain of computer is the central processing unit abbreviated as a CPU (Fig. 9.12). It controls different parts of computer that includes control unit, memory unit and arithmetic and logic unit (ALU).

Control unit is the central part of CPU. It interprets instructions and directs other parts how to operate? A major function of this unit is to manage the sequence and operations under instructions (programme). The CPU sends data to input memory and then to ALU where addition, subtraction and other operations are done. From there, data is brought back to memory and finally sent to output unit. The CPU supervises all the operations carried on by the computer.

The memory unit consists of RAM and ROM, which are abbreviations of “Random Access Memory” and {Read only Memory” respectively. This unit is also known as temporary memory. Data from input device or hard disk is first carried to RAM before processing it. Some informations are already fed permanently to the ROM. When computer is turned on, ROM initiates the operating system.

Arithmetic and logic unit (ALU) does mathematical operations such as addition, subtractions, multiplication, division etc. and also it performs logical operations such as comparison between two things.



Fig. 9.12: CPU

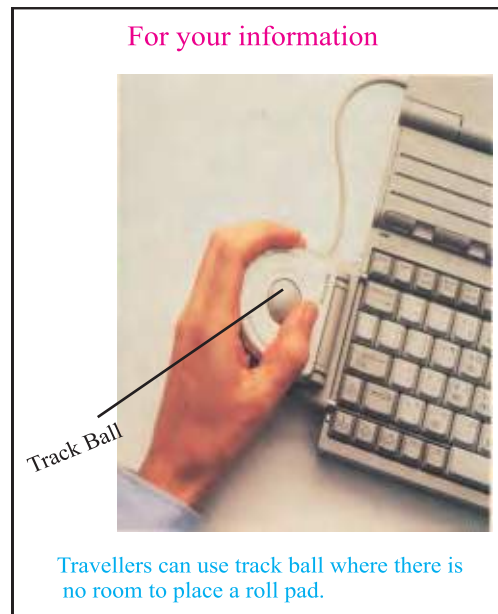

In the modern computers, control unit and arithmetic and logic units are included in the same microprocessor. Microprocessor is such an integrated circuit that consists of small silicon chip. Thousands of electronic components are installed on it. This chip possesses the entire problem solving capability of a computer.

### iii. Output Devices

An output device receives informations from CPU and displays the operation carried out by computer. A common example of output is the monitor. A monitor is such an output device on which all the computer operations can be watched on the screen like television.



Monitor

Printer is another output device which prints the results of processing on paper. Printers are of many types that include dot matrix, laser, inkjet and bubble jet etc. Speaker converts signals into sound, so this is also an output device. A robot acts on the advice of computer, therefore it is included in output devices.

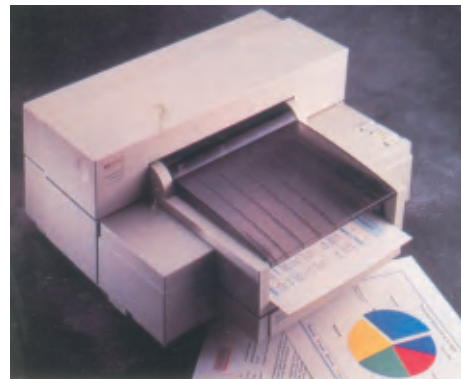

Printer

Output of computer can also be recorded on the cassette, floppy disk or C.D. Beside sound, video films and computer data is stored on C.D. That can be thereafter watched on computer or T.V. screen.

### iv. Information Storage Devices

Not more than a few years before it was assumed that the only device to store and get informations are the books. But with the advancement in information technology, other information storing devices such as audio, video cassettes, compact disks, floppy disks, hard disks etc. have become very popular. Offices, banks, universities and other institutions are transferring their records on these devices rather than to keep it on papers. These devices can store too much information in a little space. Moreover, it is easier to use them when required.

#### (a) Audio and Video Cassettes

Audio cassettes are used in a tape recorder and the video cassettes in a VCR. Both of them consist of plastic tapes, which is coated with a magnetic materials. Sound or picture is converted into electrical signals and sent to audio or video heads. Signals produce varying magnetic field in the heads. When tape runs over the head, the magnetic field changes the pattern of magnetic material on the tape.



Audio - Video cassettes

In this way audio or video signals are recorded on the tape. To reproduce sound or picture, the reverse process is done. This time, head converts magnetic recording into audio and video signals again. The speaker changes the audio signals into sound and the picture tube of T.V. changes video signal into picture.

### (b) Compact Disk

This is an aluminium or plastic disk with shining surface. It is made for digital recording. In this recording millions of tiny pits are engraved on the disk. Its pattern corresponds to audio and video signals. The shining spaces between the pits are called “flats”. For the replay, a laser beam scans the disk. This is known as reading of C.D. The flats reflect beam, which is equivalent to “1” in digital language. The pits do not reflect beam, which is 0. All 1’s and 0’s form digital signal. A circuit in the C.D. player converts digital recording to analogue electric signal. This signal is amplified and sent to the speaker or picture tube. The quality of sound produced by digital recording of C.D. is much better as compared to that of cassette tape. Moreover, a head or needle does not touch the C.D. as in case of cassette tape, but instead, only the laser beam touches it. That is why no scratches are formed on the C.D. and it works for a long time with the same performance.



Compact Disk

### (c) Floppy Disk

Floppy disk is a soft plastic disk over which a layer of magnetic material such as ferrous oxide is coated. Informations are stored on it in the form of magnetic pattern. It is kept in a plastic cassette for protection. When it is inserted in the computer, the floppy driver rotates it fast. A head reads or writes data on the disk.



Floppy Disk

### (d) Hard Disk

A hard disk consists of two or more plates made of hard metallic material. Plates are mounted on a spindle that rotates fast. Plates are kept in a case. Each plate is coated with magnetic material on which data is recorded in magnetic pattern. To read recorded data or to write, each plate is provided with a specific head. Much more information can be stored on the hard disk as compared to floppy disk. A hard disk is the permanent part of a computer, and is installed inside the computer.



Hard Disk

## 2. Software

It is not possible for a computer to solve any problem unless it is provided instructions in such a language that is understandable for computer. Different instructions are needed for different tasks. These instructions are fed through magnetic tape, C.D. And floppy disk etc.

**The instructions given to the computer for some task  
by electronic method are called software.**

It includes operating system, computer language and programmes.

### Programme

Programme is a list of instructions for a particular task. Under these instructions, the computer processes data and converts it into information. Preparing such a list of instructions is called programming or software engineering. A person writing a programme is known as programmer. Not everyone does write a programme, but pre written programmes are available in the market. Most of the people use them.

A few of the tasks done by different programmers are given below:

#### (i) Word Processing

The use of computer for writing matter, editing, storing and printing is known as word processing. In word processing, major task is to type matter by keyboard. Writing words in different styles and colours is possible in it. Word processing has too much importance in printing and publishing books. In such programmes there is also provision for correcting spelling and grammatical mistakes.

#### (ii) Graphics

There are certain programmes which provide facility to draw straight and curved lines. These programmes are used to draw diagrams and pictures. Colours and shades can also be filled in pictures. Drawing lines, making pictures and designs by computer is called graphics.

#### (iii) Data Management

To store data in different files and rearrange them to get requisite results when needed is known as data management. Educational institutes, banks, libraries, hospitals, offices and big commercial organizations store informations, make amendments in them, keep different records and run their systems with the data managements.

## 9.5 Analogue / Digital Converters

Before discussing analogue / digital converters, let us know what are the analogue / digital signals?

We are familiar with different quantities. Such quantities, which increase or decrease continuously, are known as analogue quantities. Distance, time, velocity and temperature are good examples of analogue quantities. When we note time from a watch with arms, it could be any time from zero to twelve hours. As the arms rotate continuously on the dial, the time advances continuously. This time is an analogue quantity and the watch with arms would be called analogue watch.



Analogue Watch

In comparison to that digital quantities are not continuous. For example, the time on a digital watch does not advance continuously but the display changes once in one second. Let us now take up analogue and digital signals. You have studied alternating current. Its graph of voltage versus time is shown in Fig. 9.13. The graph shows that the voltage varies continuously between maximum and minimum values. Hence voltage is an analogue quantity.



Digital Watch

When a person speaks into microphone, it produces alternating current in the circuit corresponding to sound. This is called the electric signal of sound. Since the voltage varies continuously according to sound, therefore, this signal is analogue signal. If this signal is fed to the amplifier, which is an analogue circuit, it amplifies the signal without changing its shape. The speaker thereafter converts this signal into loud sound.

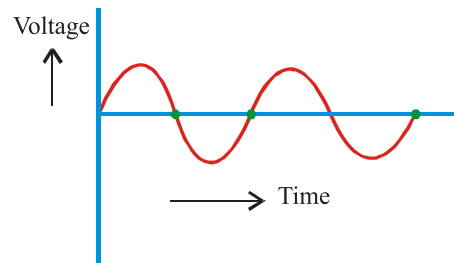

Fig 9.13.

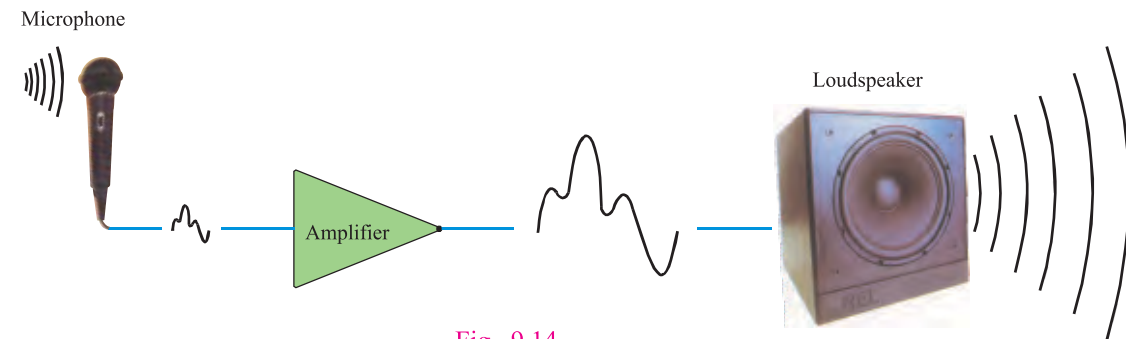

Fig. 9.14

**Analogue signals represent continuously varying voltage**



During last few decades, scientists and engineers have devised such circuits, which convert informations into digital signals. Digital signals are not continuous. These consist of two types of electrical pulses; one is the high voltage pulse and the other low voltage pulse. High voltage pulse is also called as on or “1” while the low voltage pulse as off or “0”.

**Digital signal consists of discrete on / off electrical pulses.**

Digital signals are based on binary number system in which the base of counting is 2. You have learnt to write figures on the base of 2 in junior classes. As the figure 5637 on the base of 10 (in decimal system) is actually:

$$5637 = 5 \times 10^3 + 6 \times 10^2 + 3 \times 10^1 + 7 \times 10^0$$

or  $5637 = 5000 + 600 + 30 + 7$

Likewise, the figure 361 on the base 2 in binary system has the meaning

$$361 = 1 \times 2^8 + 0 \times 2^7 + 1 \times 2^6 + 1 \times 2^5 + 0 \times 2^4 + 1 \times 2^3 + 0 \times 2^2 + 0 \times 2^1 + 1 \times 2^0$$

or  $361 = 256 + 0 + 64 + 32 + 0 + 8 + 0 + 0 + 1$

In the binary system, we will write the figure 361 as

$$361 = 101101001$$

A simple method to write figure 361 in the binary system is that goes on dividing 361 by 2. Write down all the remainders in sequence starting from left side. This will be the required figure. The division of 361 by 2 is shown. If we write down the remainders in sequence then the figure becomes 101101001. This is the required figure.

2	361	
2	180	1
2	90	0
2	45	0
2	22	1
2	11	0
2	5	1
2	2	1
2	1	0
	0	1

Letters are also changed into binary coding like figures and then converted into voltage pulses. In this way all messages can be converted into digital signals.

There are a few problems in interconnecting computers at far off places. It is because most of the communications are made through telephone wires, which are basically laid down for transmission of sound. The signal of sound is analogue that can easily pass through wires but the signal of computer is digital that cannot pass through wires. Therefore, computer is connected to telephone wires through a device, which converts digital signal into analogue signal.

On the other end the same device converts analogue signal coming from wires into digital signal before it is allowed to enter the computer. This device is called modem, which is abbreviated from

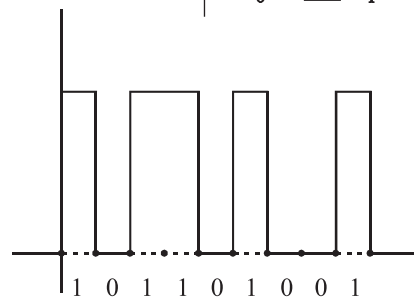

Fig. 9.15 Digital signal of figure 361



modulator / demodulator. If you want to interconnect computers in the same room or same building, it does not require modem.

## 9.6 Information Technology

We are living in the age of information. Various kinds of inventions have made it possible to get too much information in very short time. Information can be exchanged. These can be made available for use. Games, music and other entertainment programmes being held on the other side of the globe can be watched now.

**The scientific method of storing information, processing and using them properly and their communication is called information technology.**

### Telecommunication

Communication to far off places in a more affective way has always been a challenge for scientists. In 1901, telegraph signal was transmitted and received through electromagnetic waves for the first time without using wires. Its inventor was Marconi. In 1906, first human voice was transmitted. Now-a-days, besides telephone, fax machine, computer and Internet etc. are the main sources of contact. By these devices informations are transmitted from one place to another in the form of words, sound, pictures and computer data.

**The methods used for instant communication of information to far off places are called telecommunication.**

In all communication methods, informations are transmitted after converting them into electric signals. Electric signals are sent through wires, radio signals through air and light signals through optical fibres. Radio and television are the main sources of telecommunication. Some other sources are given below.

#### (i) Telegraphy

In this, messages are transmitted in the form of Morris codes. Informations are changed into electric pulses and then transmitted to other places. On the other end these are again converted into audible signals. In this method experts are required to send codes to decode the message received form the other side. This method is very slow.



Morris key used in telegraphy

#### (ii) Telephone

This is an advanced form of telegraphy. Direct conversation is made through telephone instead of using codes. One part of telephone handset is the microphone and the other part is a receiver. Carbon granules are filled in microphone over which a metallic diaphragm is fixed. When some one speaks into microphone, the diaphragm vibrates that causes variation in pressure on the

carbon granules. Change of resistance occurs due to variation in pressure and the current in the circuit varies. Thus microphone changes sound into electric signals, which are transmitted through wire to the receiver at the other end of line.

There is also an iron diaphragm in the receiver under which an electromagnet is placed. The variation in the current passing through the coil of magnet causes variation in the force of magnet, due to which diaphragm moves back and forth in accord with the signal. The vibrating diaphragm produces sound (Fig. 9.16).

Electric signals of telephone pass through metallic wires. In the modern system, electric signals are first converted into light signals and then transmitted through optical fibres. In every country, there is a network of telephone exchanges that provide a contact between two telephones. For international contacts, microwave transmissions or satellites are used (Fig. 9.17).

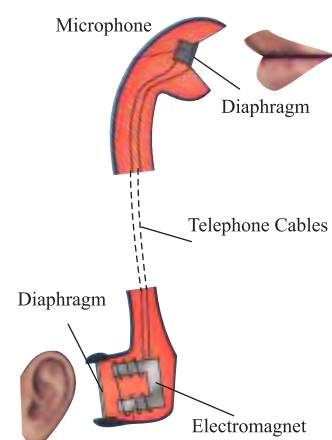

Fig. 9.16

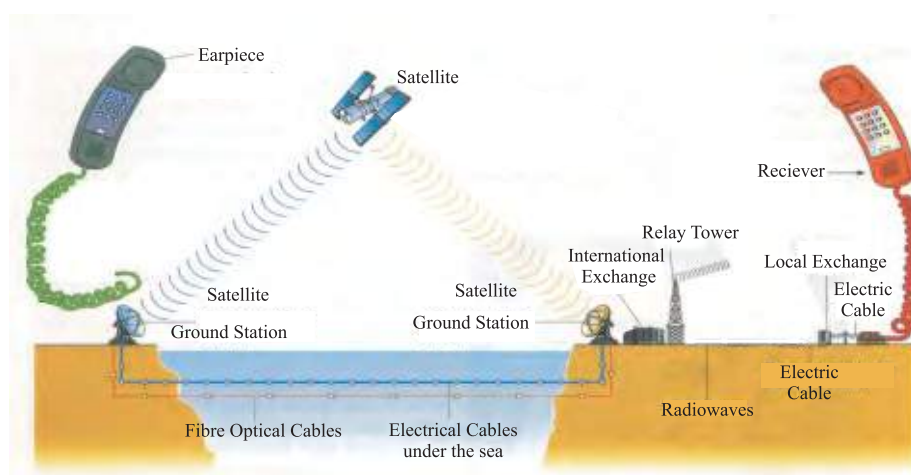

Fig. 9.17

### (iii) Mobile Telephone

Now-a-days the use of mobile telephone is very common. A mobile phone sends and receives messages through radio waves. It carries a radio transmitter and a receiver inside it. The transmitter converts sound into radio waves which are received by a nearby station linked with the telephone network, it transmits the radio signals onward.

The area of each station of the network is called a cell. When a call reaches from one cell to another, it is connected to the required



Mobile Phone

station by an automatic system. Mobile phone is also called as cellular telephone by virtue of cell system. The receiver of mobile phone again changes the radio signals into sound.

#### (iv) Telex Machine

This consists of a teleprinter and an exchange machine. Message is sent from one place to another by this machine. Message is typed on the telex machine. Exchange machine changes it into electric signals that reach the other telex machine through telephone line. The teleprinter prints the message on paper. Since the whole message has to be typed on this machine, therefore, too much time is wasted. This machine has been now replaced by fax machine.

#### (v) Fax Machine

This machine is used to send and receive documents and pictures from one place to another. The word “Fax” is the short name of “Facsimile” that means to reproduce a document or picture in exactly the same form. Fax machine first makes the image of document, changes it into electric signal and then transmits it through telephone line. The fax machine, that receives the signal on the other side, reproduces it in the form of image print on the paper.



Fax Machine

### Communication systems

The electronic transfer of information from one place to another is known as communication. The electromagnetic devices used for this and method to transfer information is known communication system.

The data to be transferred may consist of sound, text, video and graphics etc. The devices involved in the transfer of information could be telegraph, telephone, radio, television or computer. The distance could be as short as the next room and could be as long as the information may be sent to the other end of the solar system.

When we talk with reference to computer, communication means the contact of one computer with the other due to which they exchange information with each other. The communication between the computers takes place only when data reaches from one computer to the other in the form of electronic signal. Three basic components of communication system are:

1. The sending device
2. A communication link or medium
3. The receiving device

The information sending device in most of the cases is a computer, which gives information in the form of digital signals. These are converted into electric signals by a modem so that these can be transmitted. For the transmission of electric signals, a medium or link is

required. On the receiving end signals are again changed into digital ones before allowing them to enter into the computer (Fig. 9.18).

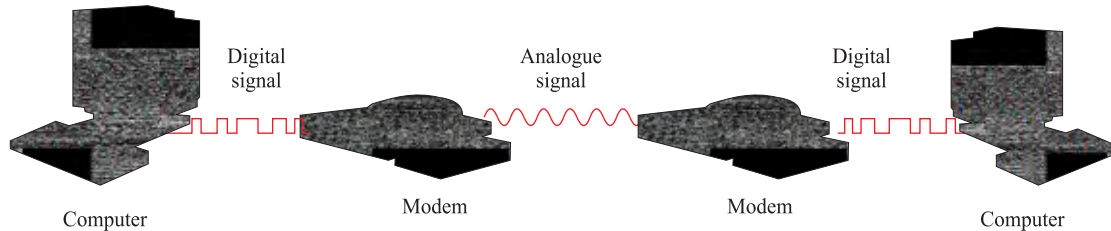

Fig. 9.18: Communication Link

Commonly used links are of three kinds. The first one is the telephone wire, which are also called boosted pairs. The second one is the fibre optic technology. The transmission of data through optical fibres is much faster, and thousands of signals can pass through a fibre at a time. Moreover, signals do not suffer loss of energy in the way. The third link is the microwave transmission. You have learnt about it in the section of satellite T.V. Signals are transmitted to the satellite through microwaves by a ground station. The satellite retransmits them to the required ground station after amplifying them. From there signals are transmitted onwards through other media.

## Internet

Internet is the name of interconnection of millions of computers. Not only you can exchange information through Internet but also you can get information of every type. The individuals and organizations from all over the world have stored information on the Internet in the form of websites. Websites are huge collection of information. You can make use of it when needed. Companies can also provide details of their products on websites and can advertise them. Professionals such as doctors and engineers etc. can exchange latest information about their problems. You make contact with Internet service provider ISP through your computer and it provides you the international contact.

The computers linked with an Internet use uniform communication process called the protocol. The protocol used in Pakistan is the “Transmission Control Protocol/Internet Protocol” which is abbreviated as TCP/IP.

## E-mail

A major use of Internet is the quick mailing called electronic mail or simply E-mail. Through this, you can send your message immediately to any person all over the world. If the concerned person is not present, he can read the message later as well. First of all you connect your computer to Internet and type your E-mail address and password. This opens your mailbox. Here you can read your mail as well as you can send E-mail to others. To send E-mail to

someone you type the E-mail address of that person and the message and then press send button. The message goes to the mailbox of the required person.

Now-a-days voice-mail has become possible in which your voice reaches the receiving end in original. You can also make two-way conversation. In a video conference, television, video and sound technology is linked with computer through which persons at different places can see, listen and conversant with one another.

### IMPORTANT POINTS

- Electronics is the knowledge of behaviour and control of electric current.
- Semi-conductor is such a substance whose ability to conduct current lies in between conductors and insulators.
- If the silicon crystal is doped in such a way that its one part becomes N-type and the other P-type then it is called a P-N junction diode.
- That device which is used to convert A.C. voltage to D.C. voltage is called rectifier.
- Radio waves are a type of electromagnetic waves. These are also called carrier waves.
- Computer is an electronic machine that receives raw data and processes it into useful information under the given instructions.
- The components of computer that can be physically touched are called the hardware.
- The instruction given to the computer for some task by electronic method is called software.
- Programme is a list of instructions for a particular task. Under these instructions, the computer processes data and converts it into information.
- The use of computer for writing matter, editing, storing and printing is known as word processing.
- Drawing lines, making pictures and designing through computer is called graphic.
- To store data in different files and rearrange them to get requisite results when needed is known as data management.
- Such quantities, which increase or decrease continuously, are known as analogue quantities.
- Analogue signals represent continuously varying voltage.
- Digital signals consist of discrete on/off electrical pulses.
- The scientific method of storing information, processing and using them properly and their communication is called information technology.

- The methods used for instant communication of informations to far off places are called telecommunication.
- The electronic transfer of information from one place to another is known as communication.
- The electromagnetic devices used for transfer of information and method to transfer information is known as communication system.

## GLOSSARY

<b>Electronics:</b>	Knowledge of behaviour and control of electric current.
<b>Semi-conductor:</b>	Material with conductivity in between conductors and insulators.
<b>N-type Semi-conductor:</b>	That has more free electron.
<b>P-type Semi-conductor:</b>	That has more holes.
<b>Rectifier:</b>	Device to change A.C. into D.C.
<b>Computer:</b>	Machine that changes raw data into useful information.
<b>Hardware:</b>	Components of computer, which can be physically touched.
<b>Input Devices:</b>	Devices to enter data in the computer.
<b>Central Processing Unit:</b>	Part of computer that controls all operations in the computer.
<b>Output Devices:</b>	Devices, which display computer operations.
<b>Information Storage Devices:</b>	On which information can be stored.
<b>Audio and Video Cassettes:</b>	Magnetic tapes to record audio and video signals.
<b>Compact Disk:</b>	Disk for digital recording in the form of pits and flats.
<b>Floppy Disk:</b>	Soft plastic disk for digital recording.
<b>Hard disk:</b>	Disk consisting of metal plates for digital recording.
<b>Software:</b>	Instructions to computer for any task.
<b>Programme:</b>	List of instructions for computer to do a particular task.
<b>Word Processing:</b>	Writing, editing and printing through computer.
<b>Graphics:</b>	Drawing pictures and designs on computer.
<b>Data Managing:</b>	Storing data in files, its rearrangement and obtaining



	required results.
<b>Analogue/Digital Converter:</b>	Device changing analogue signal into digital and vice-versa.
<b>Telecommunication:</b>	Transmission of information to far off places
<b>Fax Machine:</b>	Machine to send and receive documents and pictures through electronic signals.
<b>Communication System:</b>	Electronic method to transmit information from one place to another.
<b>Internet:</b>	Contact of computers.
<b>E-mail:</b>	Mail sent through electric method.

## QUESTIONS

**Q. 1.** Four answers are given for each sentence, select the correct answer

- (i) In p-type semi-conductor, most of the current is due to
- |                    |           |
|--------------------|-----------|
| (a) free electrons | (b) holes |
| (c) positive ions  | (d) heat  |
- (ii) Diodes are used to:
- |                            |                            |
|----------------------------|----------------------------|
| (a) convert A.C. into D.C. | (b) convert D.C. into A.C. |
| (c) store charge           | (d) change voltage         |
- (iii) Electric signal is converted into digital signal by
- |              |             |
|--------------|-------------|
| (a) keyboard | (b) monitor |
| (c) scanner  | (d) modem   |
- (iv) In binary system, 37 is written as
- |            |            |
|------------|------------|
| (a) 101101 | (b) 100101 |
| (c) 110011 | (d) 101011 |
- (v) Analogue signal is recorded on
- |                   |                 |
|-------------------|-----------------|
| (a) magnetic tape | (b) floppy disk |
| (c) hard disk     | (d) C.D.        |

**Q. 2.** Fill in the blanks.

- (i) Electronics is the knowledge of behaviour and control of \_\_\_\_\_.

- (ii) A \_\_\_\_\_ beam scans C.D. for replay.
- (iii) Programme is a list of \_\_\_\_\_.
- (iv) The orbit of a hovering satellite is known as \_\_\_\_\_ orbit.
- (v) In the picture tube, an electron gun throws a beam of \_\_\_\_\_ on the screen.

**Q. 3.** Mark '✓' against true and '✗' against false statement in the following sentences.

- (i) The quality of sound from digital recording of C.D. is much better as compared to that of cassette tape.
- (ii) Analogue signal consists of distinct on/off electrical pulses.
- (iii) In cable T.V. electrical signals are converted into radio waves.
- (iv) Fax machine is used to send and receive documents and pictures from one place to another.
- (v) At least four hovering satellites are required to send transmissions all over the world.

**Q. 4.** What are n-type and p-type semi-conductors? Where are they used for?

**Q. 5.** How is a diode forward biased and reverse biased? Describe different kinds of diodes and write few uses of them.

**Q. 6.** What are radiowaves? How radio transmissions reach us?

**Q. 7.** How does television work? Explain briefly the satellite T.V.

**Q. 8.** Write an explanatory note on television.

**Q. 9.** What are the main parts of a computer and what do they work?

**Q. 10.** Write a note on communication system.

# 10 SCIENCE AND TECHNOLOGY

In this chapter you will learn:

- Role of Science and Technology in the Development of the Country
- Lasers
- Fibre Optics
- Satellites and Radar
- Radioactivity
- X – rays
- Ultrasound
- E.C.G, E.E.G, MRI, C.T. Scan, Angeography
- Important Industries of Pakistan

## 10.1 Role of Science and Technology

We had extremely limited resources in the beginning when Pakistan came into being. Most of the things of daily usage had been imported from other countries. In the field of science and technology we were lagging so much that even a bicycle or a fan was not manufactured. By the grace of God, motor cycles, cars, tractors and even ships are now made in Pakistan.

No doubt, it is the age of science and technology. Without the progress in this department, no country can keep the stability of real independence. It always depends on others for its necessities.

In the medical sector we have made higher achievements. In modern diagnosis, Ultrasound, CT scan, ECG, MRI and in modern ways of treatment surgery of vital parts of the body angiography, angioplasty etc. are becoming common. There is also advancement in laser treatment whereas radiotherapy is also onto the road of success.

Agricultural development is quite evident. In the past, when cultivation was done by ploughs. But now almost everyone is cultivating by tractors and modern equipments. Efforts made by agriculture department are appreciable for providing good seeds for good production. Now many universities are linked with this department.

Evident Progress is attained in industries such as sugar, cement, glass and ceramics. Sports items, surgery tools and hand made carpets, made in Pakistan, are very popular in the world. The use of optical fibre for the improvement of communication system, has placed us among the developed countries. In engineering department besides heavy machinery, the role of cottage industry is exemplary.

After achieving the enrichment of uranium, Pakistan made a nuclear test and proved to the world that it has full capability of its defence. Pakistan is not lagging behind its opponent in manufacturing long range missiles, tanks and ships also.

## 10.2 Lasers

Laser is an abbreviation of the light amplification by stimulated emission of radiation. Laser is an intense beam of light in which all the waves have the same wavelength and all are in phase. Such a beam of light is called monochromatic. Laser beam travels in one direction, whereas ordinary light spreads out. That is why the ordinary light covers a large distant area while the laser does not spread. Due to this characteristic of laser, different figures can be displayed in space. Because laser is an amplified light i.e., it intensifies the light. To raise the intensity of light, it is amplified again and again. For this purpose two plane mirrors are used.

### Tidbits

The first laser ever used is ruby crystal which is excited by a powerful flash of light.

Usually crystals e.g., ruby, glass or semi-conductors are used to make lasers. Beside these, some gases are also used for this purpose.

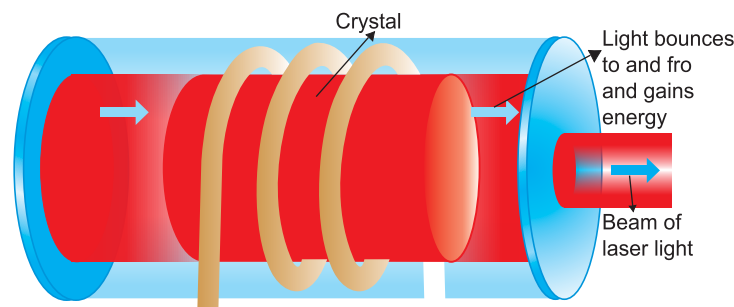

Fig. 10.1: Apparatus used in laser

### Applications of Laser

Now-a-days, use of laser has become very common. A few of the applications are given below:

## Surgery

Lasers are employed as light scalpel, that is surgical cutting and coagulation tool. When a laser beam is focussed onto a tissue, it cuts down after being too much hot. Thus only that area is cut on which it is focussed. Laser does not harm the surrounding portion. By laser surgery the blood coagolatics in capillaries so it protects from bleeding. Laser surgery is of special importance in liver operation.

## Ophthalmology

Argon lasers are presently used for operating cataract and glaucoma.

## Dermatology

Laser radiations are used for many skin diseases and removal of stains and pigments in the skin.

## Dentistry

Laser presents promising application in clinical dentistry in which by means of photocoagulation nerves a special painted material is fused into teeth cavities.

Laser surgery is also used for the following diseases:

- 1- Laser surgery has been used to treat cancer.
- 2- Lasers are used to crush gallstones and kidney stones without any surgery, the process is called lithotropsy.
- 3- Lasers are used to mend retina of human eye.
- 4- Lasers are used to reshape cornea to improve poor vision.
- 5- By laser, holes can be drilled in the hardest material e.g., steel, diamond, also in glass or metals precise patterns are made by cutting very carefully.
- 6- Laser is used to produce three-dimensional images called holograms. This process is called holography.
- 7- Military purposes are also fulfilled by laser technology e.g., by laser guided missiles and bombs, aircrafts and tanks can be hit accurately.
- 8- Use of lasers and optical fibres have revolutionized the communication system.
- 9- In super markets, record of prices of items is stored in computer. To sell an item it is scanned by laser and every detail appears on screen.

## 10.3 Fibre Optics

### Principle of Fibre Optics

When a ray of light passes from a denser to a rarer medium it bends away from the normal to the interface. Now if we go on increasing the angle of incidence then at a particular angle of incidence, the angle of refraction will become  $90^\circ$  (Fig.10.2). When the angle of incidence is made greater than  $\theta_c$ , the ray does not refract but reflects into the same medium. It is called the total internal reflection.

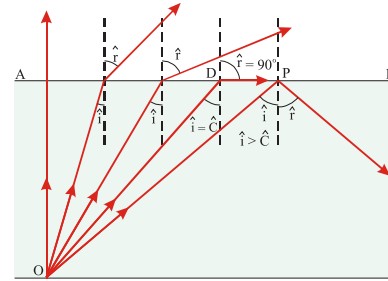

Fig. 10.2. Total internal reflection

Light through optical fibre also passes due to the total internal reflection. Optical fibres are fine strands of glass. The fibres have a core of pure glass, which is surrounded by a different kind of glass. These days in telecommunication optical fibres are replacing metal cables for transmitting telephone calls in a better way. In this way each caller's voice is changed into a light signal.

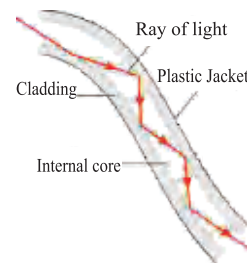

Fig: 10.3. Optical fibre

### Uses

Optical fibre enables doctors to look inside the human body. As optical fibres are very thin so it can be easily passed into the body to get the required picture. In eye surgery light is obtained from fibre optic light guide. Optical fibre can transmit thousands of telephone calls. T.V. programmes can be transmitted by one or two flexible and thin hair-like optical fibres.

## 10.4 Satellites and Radars

### Satellites

T.V. displays slides about the address of any celebrity or about different matches, world Olympics, Taravah in Ramazan-ul-Mubarak and sacred occasions of Haj, before the commencement of programme. All these programmes are relayed through artificial satellite.

There are some communication satellites which relay the telephonic conversation and send the T.V. programmes all over the world. These revolve in particular orbits, which are called geo-stationary orbits.

Electrical power for the satellites is provided from panels of solar cells. These panels convert solar energy to electricity. The spacecraft travelling far away from the Sun carry small nuclear reactors with them to generate the required power.



## Radar

The word radar is derived from radio detection and ranging. Radar is a reliable instrument for sending and receiving electromagnetic waves, which are usually in the form of radio waves or microwaves. Electromagnetic waves travel with speed of light. Its characteristics depend on the wavelength. Radar remote detection system is used to locate and identify objects.

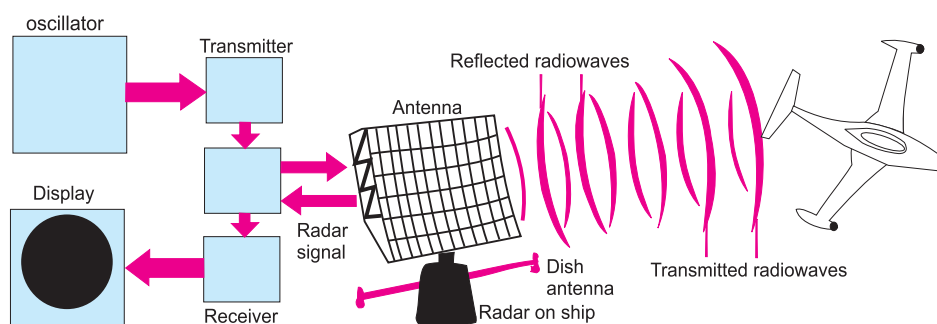

Fig. 10.4

Radar transmits, short pulses of high frequency radio waves by means of a revolving aerial. When pulses strike an object, these are reflected, which are received by radar antenna. A trace or shape of that object appears on a screen (Fig. 10.4). Radar can determine a number of properties of distant objects such as its distance, speed and direction of motion.

Radar controls air traffic both civilian and military. Large network of ground based radar system helps air traffic controllers to keep track of aircraft to prevent mid-air collisions. Commercial and military ships also use radar to make ships alert of obstacles especially in bad weather and dim light. Military forces around the world take the help of radar to detect aircraft, missiles, troops movement and ships at sea. In this scientific age radar is used to know about weather and to forecast for rain or storm. Some spacecrafts also carry radar for mapping the surface of planets covered by thick clouds.

## 10.5 Radioactivity

The elements having atomic number greater than 82, continuously go on emitting radiations. These elements are called radioactive elements. The phenomenon of emission of radiation from these elements is called radioactivity. These radiations are of three types  $\alpha$ ,  $\beta$  and  $\gamma$ .

In 1896, Henry Becquerel by chance discovered radioactivity. He observed that uranium salt makes the photographic plate foggy. The process continued despite of uranium was covered by black sheet.

### Alpha Radiation

Alpha radiations comprise of fast moving helium nuclei, mass of helium is 4 and charge is +2. These carry positive charge. Compared to  $\beta$  and  $\gamma$ -rays the range and penetrating power of  $\alpha$ -radiation is small.

### Beta Radiation

Beta particles are fast moving electrons. Its mass number is zero and charge number is 1. Its penetrating power is greater than that of  $\alpha$ -particles.

### Gamma Radiation

Gamma rays are high energy carrying electromagnetic radiations.  $\gamma$ -rays are identical with X-rays but gamma rays are of short wavelength, and have high energy. Their range and penetrating power are also greater.  $\gamma$ -rays are ejected from the nucleus. These are not affected by electric or magnetic fields.

### Isotopes

Isotopes are the nuclei of the same atomic number and different mass number and have the same chemical properties, e.g., chlorine 35 and chlorine 37 are the two isotopes of chlorine.

### Radioisotopes and Their Uses

The isotopes which possess radioactive nature are called radioisotopes. There are many advantages of isotopes in some fields e.g., industry, scientific research and medicine.

- (1) In industries radioisotopes are used as tracers. These are used to check the flow of liquid in chemical plants.
- (2) The ability of a substance to absorb  $\gamma$ -rays has been adapted to keep automatic control on the thickness of paper, plastic and metal sheets as it is passed through the production plant.
- (3) Besides this radioisotopes detect the crack or leakage in the underground pipe.
- (4) Radioisotopes are being used in scientific research to study the chemical reactions on a wide scale. Phosphorus 32 and sulphur 35 are employed on living system to trace the metabolic path.
- (5)  $\gamma$ -rays are used to detect the flaws and cracks of metal parts.

- (6)  $\gamma$ -ray are employed to preserve food for a long period. If  $\gamma$ -rays are passed through food stuff, bacteria in it get killed. Food without bacteria does not go bad for a long time specially when it is stored in air tight containers. But if there occurs any change in the food it is dangerous to take such food. The treatment for this purpose needs intensive care.

### Protection and Precautions against the Radiation

The cells of the body undergo dangerous physical and chemical changes as a result of exposure to radiation.

1. The extent of the damage depends on nature of radiations, parts of the body exposed to radiation and duration or dose of radiation.
2. Radioactive sources should be stored carefully. It should be tagged “R” for radioactive materials.
3. Laboratory walls, floor, benches should be hard gloss painted.
4. Lab should be capable to be washed thoroughly so that any crack on the bench, the floor-wall joins should be free of radiations.
5. Clothings for the lab and out door should be kept separate.
6. Use the gloves according to situation.



Symbol of radioactivity

## 10.6 X-rays

X-rays is one of the monumental discoveries of mankind, which was discovered accidentally. When high energy electrons impinge on metal surface, very powerful radiations are emitted. These radiations are called X-rays (Fig.10.5). X-rays are those high energy photons, which are liberated from the metal due to collision of fast moving electrons. Materials which contain only light atoms do not absorb much X-rays. For example, they pass easily through most living things, but not through bones, which contain heavier atoms. This means that X-rays can be used to find defects in the bones and teeth inside the body without surgery.

### Properties of X-rays

- (i) These rays are not deflected by an electric or a magnetic field.

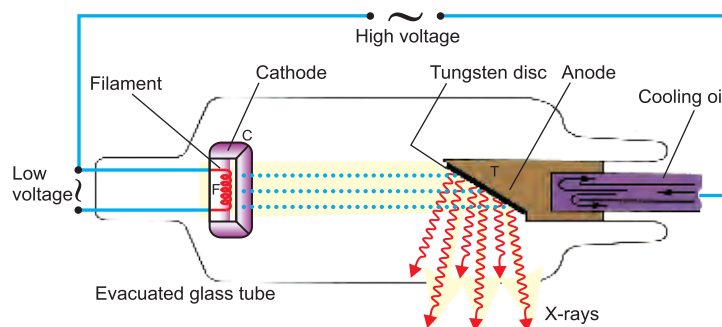

Fig. 10.5

- (ii) These are highly penetrating rays. Their penetrating power depends on the density of the objects with which they strike. Higher the density, lesser is the penetration.
- (iii) Compared to light, these are short wavelength electromagnetic waves. Their frequency is greater.
- (iv) These affect the photographic plate more than the light rays.

### Uses of X-rays

- (i) X-ray technology lets the doctors to see the depth of human tissues, to examine broken bones, cavities and to trace the swallowed objects.
- (ii) By latest experiments on X-rays, physicians have become expert in locating the diseases in soft tissues e.g., lungs, blood vessels and intestines.
- (iii) In the industrial world, even a minute flaw in heavy metallic equipments is detected by X-ray scanner, in twinkling of an eye.
- (iv) X-ray scanners are used as standard equipment for airport security.

### PRECAUTION

As X-rays can be harmful for the cells of human body, therefore, these should be applied very carefully and used if necessary.

## 10.7 Ultrasound

Ultrasound is the sound that cannot be heard because its frequency is much greater than the frequency which a normal ear can hear.

**Sounds having frequency greater than 20 kHz are said to be ultrasound or ultrasonics**

Usually two-dimensional images are obtained by ultrasound whereas the objects are three dimensional.

Recently such developments have been made in ultrasound machines that two dimensional images obtained are changed into three dimensional images by special computer software.

When the moving object reflects ultrasound then a change occurs in its reflected frequency. When probe moves near to the body, the frequency rises and when probe is away frequency decreases. How much the frequency is changed, depends upon fast or slow movement of the body.

Ultrasound of any body can be done much faster than X-rays. Without using radiation the structure of the body can be observed. Because, with the help of ultrasound the structure of internal organs of the body or any defect in them can be judged without doing any surgery, therefore, the importance of ultrasound is increasing in medical diagnosis section.

### Uses of Ultrasound

- (i) Speed of blood flow through kidneys can be determined.
- (ii) In kidneys, pancreas, gallbladder, the presence of stone can be located.
- (iii) In jaundice, condition of liver and arteries can be observed.
- (iv) Internal heart structure and irregularities in blood circulation system can be studied.
- (v) Tumor in the body or cancer in any organ can be detected.
- (vi) Any sort of obstrectries can be located.
- (vii) Ultrasound is helpful in some medical processes, e.g.
  - To break kidney stone by ultrasound.
  - Use in biopsy.
  - Extraction of extra water from lungs and abdomen in different diseases.

#### Tidbits

If dirty object is dipped in water and ultrasound is switched on, the dirt separates from the object due to vibration.

Besides this, sonar systems fitted on ships and submarines use ultrasounds, to find the hidden secrets under water.

## 10.8 E.C.G. (Electrocardiogram)

Electrocardiogram is the test that measures the electrical activity of the heart. The heart beats in a peculiar way so that blood may be pumped through the whole body. In an E.C.G. test, the electrical impulses, which are produced due to heart beating, get recorded and usually appear on a strip of paper, which is known as an electrocardiogram. Because any heart disease affects the heartbeat, so it records any problem in the regularity of heartbeat. If one feels

difficulty in breathing (dyspnoea), chest pain (angina), feeble or fast (palpitation) heart beat becomes abnormal, then it is better to have an E.C.G. in that state.

E.C.G. not only helps to discover the heart disease but also informs how well the patient is responding to the treatment. If E.C.G. recording taken at rest is normal but the patient is feeling suffocation or pressure on chest, then E.C.G. recording may be made when the patient is exercising, this may reveal the problem. From E.C.G. proof of problem in coronary artery can be had. It can be used to assess that the patient is under heart attack or evidence of previous heart attack.

#### BE CAREFUL

While exercising if the patient complains chest pain or any change in E.C.G. is observed or blood pressure drops, the test may be discontinued.

## 10.9 E.E.G. (Electroencephalography)

Recording of electrical activity of brain called brain waves from outer surface of head is said to be E.E.G. To get E.E.G. sixteen electrodes are set on different places for about 10-30 minutes and informations are collected about brain waves.

### Uses

1. To diagnose the different types of epilepsy and to enquire about the beginning of this disease into the brain.
2. To diagnose different brain diseases e.g., dementia, encephalitis and hypoglycemia.
3. To know the effect on brain (Hepatic Encephalopathy) due to liver problem.
4. To collect informations about brain death and coma condition.

## 10.10 MRI (Magnetic Resonance Imaging)

MRI is the special medical diagnostic technique that creates images of the body using the principles of nuclear magnetic resonance. This generates thin section images of any part of the body including the heart arteries and veins from any angle and direction without surgical application and in a relatively short period of time. These informations may allow early diagnosis of many diseases.

These days in medical departments MRI is specially preferred for diagnosing central nervous system. MRI scanner is better than x-ray because it can distinguish both, normal and



diseased state of a soft tissue. Provides informations about the existence of cancer in brain, hemorrhage, obstruction in brain artery etc.

## 10.11 C.T. Scan (Computerized Tomograph Scan)

C.T. Scan is a special type of X-ray, which is obtained by sending several beams of X-rays at different angles through the body instead of passing a single X-ray beam. The machine used for this purpose is called C.T. scanner. C.T. scanning technique was discovered by a British scientist Sir Geoferry Hounsfield, for which he got the Nobel award. Scanner looks like a doughnut.

For scanning, patient is laid in such a way that the body part to be examined is placed in the round tunnel or opening of the scanner. The bed is then moved slowly backward and forward to allow the scanner to take pictures of the body, without touching it.

Duration of test depends on the number of pictures and angles selected for pictures. Scanning does not hurt, but some people find it uncomfortable to lie in the tunnel, as there is little room inside the tunnel. In the same way some people get nervous because of the whirling noise of the machine, while working.

### Uses

1. To detect the blockage in intestines
2. To study about the structure of abdominal organs and condition of aorta.
3. To get knowledge for the lungs cancer and its spreading, effects on lungs due to cancer or different diseases of lungs.
4. To know about brain diseases e.g., brain cancer, brain constriction or haemorrhage, coagulation of blood due to head injury.

### Do You Know?

As more X-rays are involved in C.T. Scan than an ordinary X-ray so the doctors recommend C.T. Scan in a sound medical reason.

## 10.12 Angeography

Angeography is a way to produce inside pictures of arteries. When arteries are blocked or suffer any loss or any irregularity developed in them, then chest pain, heart attack, stroke or any other problem may occur. Angeography helps the physician to determine the source of problem and the extent of damage to the arteries segments. By angeography blockage or constriction in heart arteries are known, by which choice of treatment procedure becomes easy e.g., replacement of valve, by-pass operation or to lay a pace maker.

## 10.13 Important Industries of Pakistan

### 1. Sugar Industry

Sugar industry is one of the vital industries. Sugar is naturally present in most of the green plants and fruits. It is formed through a natural process called photosynthesis. Two main sources of sugar are sugarcane and sugarbeet.

#### Preparation of Sugar from Sugarcane

Sugar is mostly made by sugarcane. Sugar is stored in the stalks of sugarcane. Sugarcane contains sucrose, glucose, fructose, water, fibres and some other materials. From ingredients of sugarcane, sucrose is extracted in white crystals. This is called sugar.

Sugar mills are located near fields, because sugarcanes start losing its weight slowly, after it is harvested, therefore it is crushed quickly. Moreover sugarcanes require a large space, so it is difficult and expensive to carry them. Sugarbeet is second major source of commercial sugar in the world. This grows in cold climate. Sugar is stored in the roots of beets.

Sugar is manufactured through the following processes.

#### (i) Extraction of Juice

Sugarcane is cut into small pieces, the rind and nodes of the canes are separated. Then cane is crushed by crusher and juice is extracted leaving the bagasse.

#### (ii) Purification of Juice

Juice is passed through strainers to remove straws and the bagasse. Then impurities are removed from juice so that strained, purified juice is obtained.

#### (iii) Evaporation of Juice

Purified juice that contains sucrose, water and certain impurities is sent to evaporator for the removal of surplus water. The obtained syrup is changed into concentrated syrup for raw sugar. Then from concentrated syrup, white sugar is obtained. In evaporation process the juice is heated from 100°C to 110°C.

#### (iv) Crystallization

Concentrated syrup is boiled in sugar boiling plant where crystallization is carried out to the desired size of grains.

#### (v) Centrifugation

In this process, sugar crystals are separated from molasses and washed with steam if necessary.

#### (vi) Drying and Bagging

Drying sugar with hot air in dryers is then bagged for marketing.

Following by-products are obtained during manufacturing sugar:

**(a) Bagasse**

This is used as fuel in sugar mills. The surplus is being used in manufacturing of paper, chipboard and boards.

**(b) Molasses**

Most of the available molasses is exported. A small percentage is used for production of alcohol and cattle feeds.

## **2. Steel Industry**

According to the need, iron is melted, and hot air is passed to make it free of impurities. Ore is an important source of iron. By mixing oxygen in it, a compound is made. Ore is mixed with carbon and limestone and on heating it is changed into pig iron. Adding scrap iron and limestone into pig iron, it is sent back to the furnace to get pure iron. Iron is mixed with carbon or sometimes with other elements to produce extra hardness according to necessity. It is called steel. Ordinary steel contains carbon upto 1.7%. It is used for building plazas, factories, ships, aeroplanes and car bodies. To save from rust these may be coated with paint or plastic or with protective layer of zinc. Stainless steel is a mixture of chromium, nickel, molybdenum, which is used to make surgery tools and home appliances and every type of light and heavy machinery.

Pakistan steel mill is providing raw material for engineering and construction industries. And those lower level industries, which depend upon Pakistan steel mills products, are fed by it. As Pakistan has iron resources, so steel mill prepares millions of tonnes of steel. Though Pakistan's steel products are very popular but surgery tools are at the top of this list. Gujranwala and Sialkot are famous for these products all over the world.

## **3. Pharmaceutical Industry**

Pharmaceuticals are medical products, which are prescribed by doctors for different diseases. The place where these products are prepared is called pharmacy. Pharmacy simply is the preparation of medicines. The industry linked with the preparation of medicine is called as pharmaceutical industry. Earlier we were dependent mostly on imported medicines. But gradually attention was given to pharmaceutical industry. Now we prepare most of the medicine in our country. Pharmaceutical industry is based on pharmaceutical chemistry which is of course a branch of chemistry in which preparation of new compounds, its testing and its effects on the human health are examined.

## **4. Synthetic Fibre Industry**

There are two types of fibres:

- (i) Natural Fibre**
- (ii) Artificial Fibre**

**(i) Natural Fibre**

Natural fibre is obtained by natural resources e.g., cotton, jute, wool, silk, etc.

**(ii) Artificial Fibre**

Artificial fibre, is that fibre which is prepared by the man himself using different raw materials e.g., polyester, nylon, rayon, acetates, viscose, acrylic etc. These are obtained from petroleum, and are prepared by different methods. Steel fibre, carbon fibre, Teflon fibre are also fibres. The formation of synthetic fibres includes the process like polymerization, spinning stretching, cutting and reeling.

**5. Cotton Textile Industry**

Textile is the major sector of Pakistan industry. Textile industry is mostly located in Karachi, Lahore, Multan, Faisalabad and Gujranwala. Textile industry comprises of the following sections:

- (i) Spinning
- (ii) Weaving and fabric formation
- (iii) Garments manufacturing

**(i) Spinning**

Cotton bales are sent to the textile mills where cotton fibres are changed into yarn.

**(ii) Weaving and fabric formation**

Fabric is made from yarn. Two methods are employed for it.

**Weaving:** Here the fabric is made on looms.

**Knitting:** In this process fabric is knitted on machines.

First of all, fabric is cleaned, impurities are removed from it and then fabric is dyed or printed.

**(iii) Garments Manufacturing**

Garments from different fabrics are stitched to make it ready. Here cutting, stitching and pressing departments are involved.

At the time of independence of Pakistan, textile industry had no base as was the case with almost all industries. Hence Pakistan was entirely dependent upon imported yarn as the hand-made looms were insufficient to meet the country demand. But now, major contributions towards the foreign exchange earned by Pakistan comes from textile industry.

**6. Leather Industry**

Leather is usually obtained from the hides (skins) of different animals like horses, buffalos, sheep, camels etc. Apart from this, leather is also prepared from different chemicals. It is called artificial leather.

Skins or hides are passed through different processes, which is called tannery (Fig.10.6). Finished leather from tannery is used for different purposes e.g., leather garments purses, jackets, attaché cases etc. Leather garments are mostly made in Kasur, Gujranwala, Faisalabad, and Sialkot and are popular in many foreign countries.



Fig. 10.6

### IMPORTANT POINTS

- Laser is the abbreviation of light amplification by stimulated emission of radiation. It is a device to produce an intense beam of light in which all waves have the same wavelength and all waves are in phase.
- Optical fibres are fine strands of glass. Light passes through optical fibre due to total internal reflection.
- Spacecraft is said to be an artificial satellite, which is launched in a particular orbit around the planet.
- The satellites in geo-stationary orbit to relay T.V. programmes and messages are called communication satellites.
- Radar is a reliable instrument for sending and receiving electromagnetic waves or micro-waves.
- Elements having atomic number greater than 82 continuously go on emitting radiations. These elements are called radioactive elements. The phenomenon of emission of radiation from these is called radioactivity.
- The isotopes which emit radiations are called radioisotopes.
- X-rays are high energy electromagnetic waves which pass through paper, wood, flesh etc.
- The sounds having frequency greater than 20 kHz are called ultrasound or ultrasonic.
- Electrocardiogram is a test that measures the electrical activity of heart.
- Electrical activity of brain recorded from outer surface of head, is said to be E.E.G.
- MRI is a special type of medical diagnostic technique, which makes images on the principle of nuclear magnetic resonance.
- C.T. scan is a special type of X-ray, which is obtained by sending several beams of X-rays at different angles through the body instead of single X-ray beam.
- Angiography is a way to produce X-ray picture from inside the arteries.
- In Pakistan sugar is manufactured by sugarcane and beet.

- The industry linked with medicines is said to be pharmaceutical.
- Artificial fibres like polyester, nylon, rayon, acrylic, etc. are obtained from petroleum.
- In textile industries, yarn and fabric is prepared.
- Leather industries prepare leather and leather articles from skins or hides.

## GLOSSARY

<b>Leaser :</b>	Form of light having all waves of the same wavelength and inphase as well.
<b>Fibre Optics:</b>	Communication in the form of light signals.
<b>Satellite:</b>	Spacecraft revolving round a planet.
<b>Radar:</b>	A device to detect aeroplanes etc. by means of electromagnetic waves.
<b>Radioactivity:</b>	Emission of radiation from nucleus of an atom.
<b>Isotopes:</b>	Nuclei of the same atomic number and different mass number.
<b>X-ray:</b>	High energy electromagnetic waves which pass through paper, wood, flesh, etc.
<b>Ultrasound:</b>	Sound waves of frequency greater than 20 kHz.
<b>E.C.G:</b>	Electrocardiogram , which is the electrical activity test of heart.
<b>E.E.G:</b>	X-ray of brain condition.
<b>MRI:</b>	Magnetic resonance imaging test.
<b>Angeography:</b>	A way of taking pictures from inside the arteries.
<b>C.T. Scan:</b>	A special type of x-ray at different angles through the body.
<b>Sugar Industry:</b>	Mills producing sugar from sugarcane and beets.
<b>Steel Industry:</b>	Mills manufacturing steel from raw iron.
<b>Pharmaceutical Industry:</b>	Factories of medicines.
<b>Synthetic Fibre Industry:</b>	Industries preparing artificial fibre.
<b>Cotton Textile Industry:</b>	Mills to prepare yarn and fabric from cotton.
<b>Leather Industry:</b>	Factories preparing leather and its articles from skins or hides.



**QUESTIONS**

- Q 1.** Mark(✓) against the right and (×) against the wrong statement.
- (i) There is no difference in laser light and ordinary light.
  - (ii) Hearing aid is called radar.
  - (iii) X-rays can pass through flesh.
  - (iv) Rays emitted from radioactive sources are harmless.
  - (v) Ultrasound are the sound waves of frequency greater than 20 kHz.
- Q 2.** For every statement given below, four answers are given. Select the correct answer.
- (i) Emission of radiations from nucleus is said to be
    - (a) chemical reaction
    - (b) atomic reaction
    - (c) radioactivity
    - (d) nuclear fission
  - (ii) Frequency of ultrasound is:
    - (a) less than 20 Hz
    - (b) 20 Hz
    - (c) 20kHz
    - (d) more than 20 kHz
  - (iii) Radioactivity occurs naturally from all the elements with atomic number greater than
    - (a) 62
    - (b) 70
    - (c) 80
    - (d) 82
  - (iv) The principle of light on which the fibre optics work is
    - (a) reflection
    - (b) refraction
    - (c) total internal reflection
    - (d) dispersion
- Q.3.** Fill in the blanks.
- (i) Alpha particles are deflected towards \_\_\_\_\_ plate.
  - (ii) The \_\_\_\_\_ rays are not affected by any field.
  - (iii) Optical fibres are fine \_\_\_\_\_ of glass.
  - (iv) The \_\_\_\_\_ of all waves of laser is the same.
  - (v) E.C.G. evaluates the \_\_\_\_\_ activity of heart.
- Q.4.** Give brief answers.
- (i) Which objects are used for laser?

- (ii) From where do the satellites get electrical power?
  - (iii) What are called the elements, which emit radiation?
  - (iv) Differentiate between E.C.G. and E.E.G.
  - (v) How steel is made harder?
- Q. 5. What is laser? Describe few important uses of it.
- Q. 6. Define optical fibre. Describe its construction, principle and working.
- Q. 7. What do you mean by radar system? How does it work? Write some of its uses.
- Q. 8. Discuss in detail the satellite and its types and highlight its uses.
- Q. 9. What is radioactivity? How many are the types of radiations? Describe their characteristics.
- Q. 10. What are radioisotopes? Write down some of their uses.
- Q. 11. How are X-rays obtained? Write their properties and uses.
- Q. 12. What is the difference between X-rays and C.T. scan? Which method is better for treatment?
- Q. 13. Highlight the importance and uses of steel mill.
- Q. 14. Write a note on pharmaceutical industry.
- Q. 15. What are synthetic fibres?
- Q. 16. What do you know about important sections of textile industry?
- Q. 17. Write a note on leather industry.
- Q. 18. Describe sugar processing in detail.

# 11

## SPACE AND NUCLEAR PROGRAMME OF PAKISTAN

In this chapter you will learn:

- Importance of Space Programme
- Communication and Weather Satellites
- Space Programme of Pakistan
- Nuclear Power Programme of Pakistan

### 11.1 Importance of Space Programme

Travelling in space, sometimes it had been a dream of man, which has now become a reality. Space travel became possible due to the invention of rocket. In rocket, fuel is burnt with the help of liquid oxygen and the gases produced by it are expelled from its back with very high speed and in reaction rocket moves ahead.

In October 4, 1957 Russia launched its first artificial satellite Sputnik-1 into space through rocket, that started space era. Since then thousands of spacecrafts have been launched into space. Most of them are revolving around the Earth. These have wonderfully changed the ideas of man relating to the Earth and universe.

Several space probes have also been launched into space, which have helped us in getting information about astronomical objects of the solar system. These probes have been sent to all other planets of the solar system including the moon and Halley Comet except Pluto. Several useful information have been collected from them. America in 1973 also launched its first space station Skylab-1 into space. With



Fig. 11.1: Departure of space shuttle into space

#### For Your Information

In 1976, America sent two space probes namely Viking-1 and 2 into space, which collected different samples of soil and rocks after landing on the surface of Mars.

the help of these space stations, the natural resources hidden in the Earth and planets of the solar system have been studied. In 1979, Skylab due to some fault entered back into the atmosphere and broke into pieces.

In 1986, Russia launched space station Mir into space that has been used for space research for several years. On April 24, 1990 Hubble space telescope was launched into space with the help of space shuttle discovery. The size of its mirror is 2.5 metre and its weight is 11 tonnes (Fig.11.2). Space shuttle is a form of a space craft. It can be fired into space upto the height of 300 kilometres with the help of rocket within 15 minutes. It can stay in space only for few days. Its weight is usually 2000 tonnes with full fuel. With the help of it, artificial satellites and space probes can be carried into space. In Fig. 11.1, space shuttle launching into space by rocket has been shown.

The day of 20<sup>th</sup> July 1969 will always be remembered in the history of mankind. On that day, two American astronauts namely Neil Armstrong and Edwin Aldrine landed on the moon by Apollo - 11 (Fig. 11.3). They collected the samples of soil and rocks from the moon and made their analysis which provided us many new information about the moon. More big projects are in the future plan of the man including landing on the Mars.

To get information regarding weather and climate has always been a desire and need of man. Now the scientists can make correct predictions regarding weather and climate with the help of artificial satellites launched into space. Communication satellites are very important. These facilitate us to a very large extent in television, telephone and radio communication. With the help of some satellites, scientists have come to know a lot about different galaxies, stars, planets, dwarfs, neutron star and black holes etc. present in the universe. Cosmic rays in space are also studied with the help of these. In nutshell, these satellites have brought about revolution in the human life.



Fig. 11.2  
Hubble Space Telescope

#### Interesting Information

In 1986, Russia launched space station 'Mir' into space from Kazakhstan which is the biggest and vital space station. The laboratories of the station were assembled in space. Mir is such a big space station that it looks like a shining planet in space.

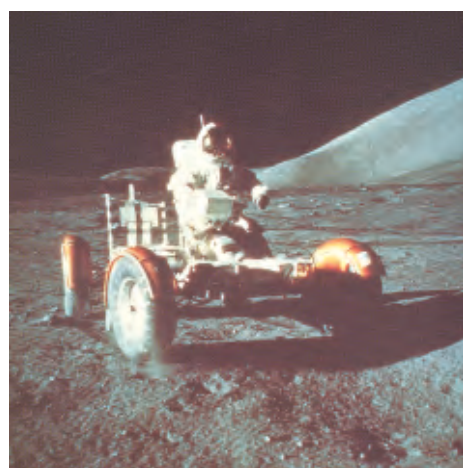
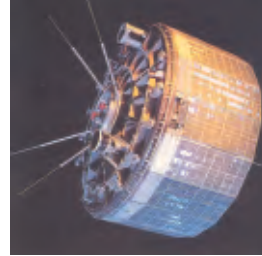

Fig. 11.3

### Interesting Information

Through artificial satellite, Metostat, cloud making pictures are taken. The meteorologists predict about the weather through the study of these pictures. They also inform people before time about cyclone and its speed and direction.



## 11.2 Space Programme of Pakistan

For the scientific development of any country, information collected by space research are proved to be very beneficial. The majority of the countries of the world, for getting benefit from this research, have launched their own space programmes. The national space agency of Pakistan realizing this need, in collaboration with Pakistan Atomic Energy Commission established an institute namely SUPARCO in 1961, which is an abbreviation of Space and Upper Atmosphere Research. Its headquarter is in Karachi. The basic objectives of this institute include space research, study of ozone layer, pollution of atmosphere, astronomy, study of radio waves, exploration of natural mineral resources through geographic information technology, establishment of ground stations and launching of space rocket and satellites into space for various purposes etc.

### Do You Know?

A branch of science in which the weather is studied for a short time by factors like rain, sunshine, temperature and air pressure is called meteorology whereas the branch which studies the climate for a long time is called climatology.

### Do You Know?

The first man went into space on 12 th April 1961 was Russian cosmonaut Yuri Gagarin.

Pakistan launched its first rocket namely Rahber into space on 7th June 1962. With it, the era of space research started in Pakistan. Up till now, more than 200 rockets have been launched into space which are hovering above from the height of 20 kilometres to 550 kilometres. Various scientific and weatheric information are being collected from them. In 1973 three rockets namely Skua were sent into space, which measure the air pressure as well as temperature. SUPARCO has established two earth stations in Karachi and Lahore for getting information from the satellites revolving in the orbits near to Earth.

SUPARCO enjoys the co-operation of renowned space research institutes of the world. The government of Pakistan has established an earth station in collaboration with American space institute NASA for exploration of natural mineral resources, which explore the geological areas of the country. Moreover in 1989, SUPARCO established an earth station at Rawat near Rawalpindi, which explores mineral resources.

SUPARCO has achieved the capability of making satellites and space rockets by day and night efforts of our scientists and engineers. In July 1990, Pakistan launched into space an indigenous artificial satellite Badar-1. Now-a-days SUPARCO is busy in the preparation of next satellite of Badar series. Next satellite of Badar series will be soon launched into space, which will help in getting several useful information. SUPARCO has done tremendous efforts regarding space research.

#### Do You Know?

Astronauts wear a special kind of dress which is called space suit. It keeps them safe from the effects of extremely low pressure in space. Apart from this, it also keeps them secure from the temperature ranging from  $150^{\circ}\text{C}$  to  $-185^{\circ}\text{C}$ .

### 11.3 Nuclear Power Programme of Pakistan

Pakistan is a developing country. After a short while of its establishment, it decided to use nuclear energy for peaceful purposes. For this purpose, in 1956, Pakistan Atomic Energy Research Council came into being. During 1964-65 and in 1973, it was reorganized and through an act autonomous status was given to Pakistan Atomic Energy Commission.

In 1972, the commission was transferred from Ministry of Science and Technology to President Secretariat. Now Pakistan Atomic Energy Commission is the most dynamic institute of the country in science and technology. In 1965 an institute namely Pakistan Institute of Nuclear Science and Technology (PINSTECH) was established for the achievement of national industrial and scientific infrastructure as well as to make up the deficiency of properly trained manpower (Fig.11.4). This institute facilitates research in nuclear science in order to bring our country among developed countries.



Fig. 11.4 PINSTECH

In this institute, special nuclear materials and highly sophisticated instruments are made on limited scale. In order to make up the requirements of fields of medicine, agriculture and industry, radio isotopes and radio pharmaceuticals are prepared. This institute also provides



technical support to industries as well as other institutes. In PINSTECH, there are also two research reactors namely PARR -1 and PARR -2 whose production is 10 megawatt and 27 kilowatt respectively (Fig.11.5).



Fig. 11.5 PARR - 1

Pakistan is one of the few countries of Islamic world, which are using nuclear energy for the production of electricity. For the achievement of this purpose, first nuclear power plant was established in Karachi in collaboration with Canada in 1972 whose name is Karachi Nuclear Power Plant (KANUPP). Its total production capacity is 137 mega watt. In this plant recycled Uranium is utilized as fuel. In 1992, in collaboration with China, another nuclear plant called Chashma Nuclear Power Plant (CHASNUPP) was established on river Indus near Mianwali. Its total production capacity is 300 mega watt. Also in this plant Uranium is used as fuel. Nuclear energy is playing a vital role in fulfilling the ever increasing demand of electricity of the country. It does not damage atmosphere too.

Pakistan Atomic Energy Commission keeping in view the national demands lays stress on importance of the achievement of nuclear energy for peaceful purposes. For this purpose, research institutes have been established across the country in agriculture, industry, biotechnology and other scientific disciplines, which are playing a dynamic role in the national development.

In the field of agriculture, by using nuclear technology, such agricultural species have been prepared whose production is comparatively more and which can fight the different diseases more effectively. In Nuclear Institute of Food and Agriculture (NIFA), a research work is carried on for exploring the diseases of crops and their remedy. In this institute the work is also conducted for the preservation of food for a long time.

In the field of medicine the use of nuclear radiations is increasing day by day. In the centres of nuclear medicines working under Atomic Energy Commission in Pakistan, through nuclear radiations the facility of diagnosing and treatment of several other diseases, apart from blood cancer and cancer of different organs is also available. In the field of industry, faults are explored in the material through different methods without breaking them.

In 1995, Pakistan Atomic Energy Commission realizing the need and utility of welding in power generation boilers, thermal and nuclear power plants, chemical, petroleum and ship

#### Do You Know?

Pakistan by making atomic explosion on 28 th May, 1998 joined the countries of the world bearing nuclear capability. Moreover, the scientists and engineers of Pakistan Atomic Energy Commission, for strengthening the defence of the country, have played a vital role by making the series of Shaheen and Ghauri indigenous missiles.

making industries of the country, established Pakistan Welding Institute (PWI) whose purpose was to provide the facility of high quality welding to the industries.

In nutshell, the scientists and engineers of Pakistan have made marvelous achievements in the field of atomic energy despite of limited resources. There is bright hope that Atomic Energy Commission will play an important role in the national economic development.

## IMPORTANT POINTS

- Artificial satellites are launched into space through rockets. The information collected through these satellites have changed dramatically the vision of man regarding universe and Earth.
- With the help of artificial satellites, scientists can now make absolutely correct predictions about weather and climate. Through these satellites several facilities have been made available in television, telephone and radio communication.
- Scientists through artificial satellites and space probes have come to know a lot of information about different galaxies, stars, planets, dwarfs, neutron star and black holes in the universe.
- SUPARCO looks after the space programme of Pakistan. The basic objectives of this institute include space research, study of ozone profile, pollution of atmosphere, astronomy, study of radio waves, exploration of mineral resources, establishment of ground stations and launching of rocket and satellites into space.
- Pakistan Atomic Energy Commission is helping in national development. This commission has established different institutes and power plants across the country for the achievement of scientific research, agriculture, medicine, industry, biotechnology and nuclear energy which are playing a vital role in the national economic development.

## GLOSSARY

<b>SPACE PROBES :</b>	Vehicles launched into space for research.
<b>SUPARCO :</b>	An institute for running the space programme of Pakistan.
<b>NASA :</b>	Space institute of America.
<b>BADAR-1 :</b>	First Pakistani artificial satellite.
<b>PINSTECH :</b>	A research institute of Pakistan in the field of nuclear science.
<b>KANUPP :</b>	First nuclear power plant of Pakistan.
<b>CHASNUPP :</b>	The biggest nuclear power plant of Pakistan.

## QUESTIONS

**Q. 1.** Fill in the blanks.

- (i) Space era started with the launch of \_\_\_\_\_ Russian artificial satellite.
- (ii) By the help of \_\_\_\_\_ satellites, lot of facilities has been made available in television, telephone and radio communication.
- (iii) \_\_\_\_\_ institute looks after the space programme of Pakistan.
- (iv) The name of first artificial satellite of Pakistan is \_\_\_\_\_.
- (v) In 1972 the first nuclear power plant was established in \_\_\_\_\_.

**Q. 2.** Mark(✓) against the right and (×) against the wrong statement.

- (i) With the help of space stations, the natural resources hidden in the Earth and the planets of the solar system are explored.
- (ii) The man landed on the moon on 20 th July 1969.
- (iii) The total production capacity of Pakistan's first nuclear power plant is 300 mega watt.
- (iv) Cancer can be cured by nuclear radiations.
- (v) Skua is the first space rocket of Pakistan.

**Q. 3.** Four answers have been given for the following statements. Encircle the right answer.

- (i) The country, which launched its artificial satellite into space for the first time is :
 

(a) America	(b) France
(c) Russia	(d) Pakistan
- (ii) SUPARCO came into being :
 

(a) in 1956	(b) in 1961
(c) in 1973	(d) in 1990
- (iii) The name of Pakistan's first artificial satellite is :
 

(a) Badar-1	(b) Rahbar
(c) Sputink-1	(d) Skua
- (iv) The total production capacity of Pakistan's first nuclear power plant is :
 

(a) 10 mega watt	(b) 137 mega watt
(c) 300 mega watt	(d) 400 mega watt

- Q. 4.** Give brief answers of the following questions:
- (i) Which space probes did collect the samples of soil and rocks from the surface of Mars?
  - (ii) What is meant by Hubble telescope?
  - (iii) Write down some advantages of artificial satellites.
  - (iv) What are the basic objectives of SUPARCO?
  - (v) Where are the nuclear power plants of Pakistan located? What is there total production capacity?
- Q. 5.** Write a brief note on the importance of space programme. Also describe the utility of artificial satellites.
- Q. 6.** Write a comprehensive note on the space programme of Pakistan.
- Q. 7.** What are the services of Pakistan Atomic Energy Commission for the achievement of nuclear energy for peaceful purposes?

## DENGUE FEVER

Dengue fever is caused by the bite of a female *Aedes aegypti* mosquito infected with dengue virus. The mosquito becomes infected when it bites a person with dengue virus in his/her blood. Dengue virus can not be spread directly from one person to another person. The risk of being bitten is the highest during the early morning and in the late afternoon before sunset. However, mosquitoes may feed at any time during the day.



The mosquito *Aedes aegypti* feeding off a human host

### Causes and symptoms

Symptoms usually begin four to six days after infection and last for up to 10 days. Symptoms of dengue fever are sudden high fever, pain behind the eyes, severe joints and muscles pain, nausea, vomiting and swollen glands.

Dengue fever can occur when a mosquito, carrying the virus, bites a human. Once in the body, the virus travels to various organs (liver, spleen etc.), where it multiplies. In severe infection, the virus production inside the body is greatly increased, and many more organs (lymph tissues, bone marrow etc.) can be affected. The viruses enter the blood stream. The cells lining the blood vessels become damaged and fluid from the blood stream leaks through the wall of blood vessels into body cavities. As a result, less blood circulates in the blood vessels and the blood pressure becomes so low that it cannot supply sufficient blood to vital organs. This state of low blood pressure is called **shock**. Shock can result in damage to the body's organs (heart, kidneys etc.) because low blood flow deprives them of oxygen. Rashes appear on skin, bleeding from nose, gums etc., also occurs in severe cases. This is called **Dengue Hemorrhagic Fever (DHF)** or **Dengue Shock Syndrome (DSS)**. Furthermore, dysfunction of the bone marrow leads to reduction in numbers of platelets. This increases the risk of bleeding.

### Treatment

Visit your doctor immediately. Doctor can diagnose dengue infection with blood test. There is no specific medicine to treat dengue fever. Medicines can be given to lower the fever and decrease the pain. Use Paracetamol and avoid medicines with Aspirin and Brufen which could worsen the bleeding. Blood transfusions may be necessary if severe hemorrhaging occurs. Oxygen should be administered to patients in shock. Patient should take rest and drink plenty of fluids.

### Prevention

Properly cover the pots having water. Do not let water stand on floor, flower vases and pots etc. Use coils, mats and sprays to kill mosquitoes. The prevention of dengue fever requires control or eradication of the mosquitoes carrying the virus that causes dengue.